

KRONOS 50

INSTALLATION MANUAL

EN

HANDBUCH

DE

MANUAL DE INSTALACION

ES

MANUEL D'INSTALLATION

FR

MANUALE D'INSTALLAZIONE

IT

1. SAFETY INFORMATION

Explanation of the safety information.



Warning – high- voltage



Warning – hot surface



Warning – danger zone

Correct and proper use

- The pump may only be used to meter liquid feed chemicals.
- The system may only be used in accordance with the technical data and specifications outlined in the Operating Manual.
- The pump may only be used if it has been correctly installed and commissioned for use.
- Any other uses or modifications are prohibited.
- The pump is not intended to meter gaseous media or solids.
- The pump may not be used outdoors without additional protection (covering, weather protection roof).
- The pump should only be operated by trained and authorized personnel, see the following table.
- You are obliged to observe the information contained in the operating instructions at the different phases of the system's service life.

Technical personnel

A qualified employee is deemed to be a person who is able to assess the tasks assigned to him and recognize possible hazards based on his/ her technical training, knowledge and experience, as well as knowledge of pertinent regulations.

Electrician

Electricians are deemed to be people, who are able to complete work on electrical systems and recognize and avoid possible hazards independently based on their technical training and experience, as well as knowledge of pertinent standards and regulations. Electricians should be specifically trained for the working environment in which they are employed and know the relevant standards and regulations. Electricians must comply with the provisions of the applicable statutory directives on accident prevention.

Instructed personnel

An instructed person is deemed to be a person who has been instructed and, if required, trained in the tasks assigned to him/her and possible dangers that could result from improper behavior, as well as having been instructed in the required protective equipment and protective measures.

Protective equipment

The transparent cover on the liquid end serves to prevent persons touching the moving rotor and prevents metering medium leakage in the event of a hose fracture.

Information in the event of an emergency

Remove the mains plug or press one of the emergency stop buttons, if fitted, in the event of an emergency.

If feed chemical escapes, also depressurize the hydraulic system around the pump. Observe the safety data sheet for the feed chemical.

2. ABOUT THIS PRODUCT

The **Kronos** is a peristaltic metering pump drive by a stepper motor. The feed chemical is conveyed by means of the rotor squeezing on the hose. No valves are needed for this. This ensures gentle handling of the metered media.

Typical applications are in processes where only a low discharge pressure is required, such as in the metering of chemicals into galvanic baths, in clarification tanks or for metering conditioning agents into swimming pools (flocclulants, activated carbon and chemicals).

The housing is made from shock-proof and chemical resistant PPE with IP65 protection degree.

It is equipped with several inputs for metering configuration. The stepper motor means that metering is infinitely adjustable.

The following provides an overview of the most important features:

- Power supply 100÷240 Vac 50/60 Hz
- Output range 0.010 ÷ 10.00 l/h @ 2bar or 0.002 ÷ 02.00 l/h @ 3bar
- Hose material SekoExtra or SekoMed (other on request)
- Powerful stepper motor, speed configurable
- Infinite adjustment of the metering output either manually or externally via 0/4-20 mA signals
- Priming function (high-speed run)
- Display of metering output on display in l/h, ml/m, Gph or %
- Reversible direction
- Housing protection class IP 65
- Tube breaking system
- Fuse 1,6A (20W)

3. DIMENSIONS AND DEVICE OVERVIEW

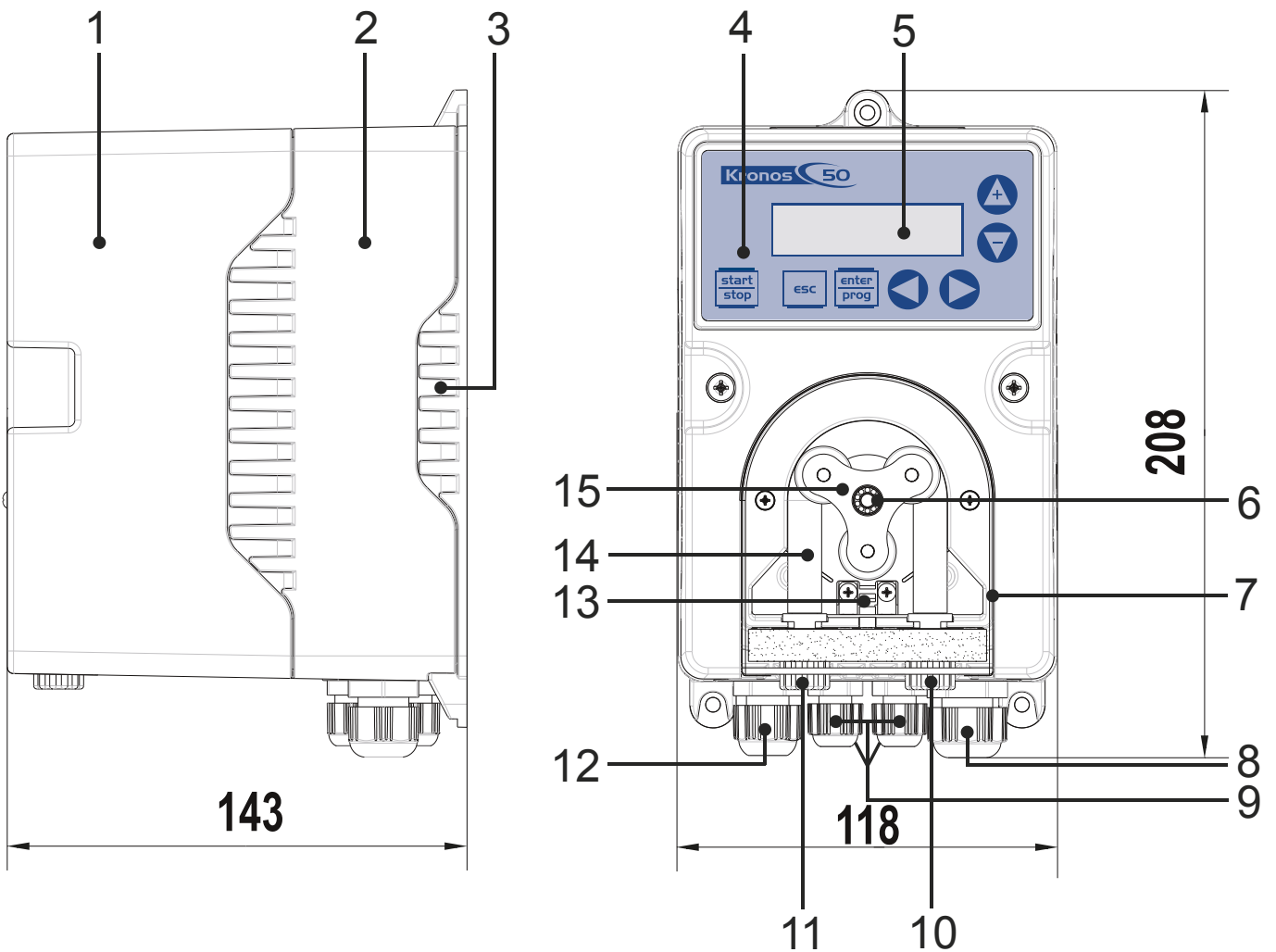

1	Housing: upper section	9	PCBs 7
2	Housing: central section	10	Discharge connector
3	Housing: bottom section	11	Suction connector
4	Control keys	12	PCB 9
5	LCD display	13	Hose rupture monitoring
6	Ball bearing	14	Pump hose
7	Transparent cover	15	Rotor
8	PCB 11		

4. DESIGN AND FUNCTIONAL DESCRIPTION

The pump is comprised of two main components:

- Driver unit (stepper motor)
- Liquid end (rotor, rollers and pump hose)

Operating unit

The device is housed in a robust plastic housing. The plastic housing is comprised of upper and lower sections, which are screwed together. The lower section contains the PCBs for power supply and connectors. The upper section of the housing accommodates the CPU, motor and display PCB with display and buttons.

The liquid end is mounted at the front and is closed off by means of a screwed transparent cover to protect against injuries. The pump hose can easily be exchanged after the transparent cover has been removed.

The rotary movement of the rotors alternately press and relax pump hose by three rollers. As a result, the liquid is sucked in and transported through the pressure hose.

The pump is operated by means of the operating unit. The desired metering level and mode are configured with this. The metering operation is controlled with the operating unit or via an external contact, level input.

5. INSTALLATION

1. Mark the bore holes on the wall
2. Drill the \varnothing 8 mm holes and insert the dowels supplied
3. Fix the bracket to the wall
4. Hook the device at the top

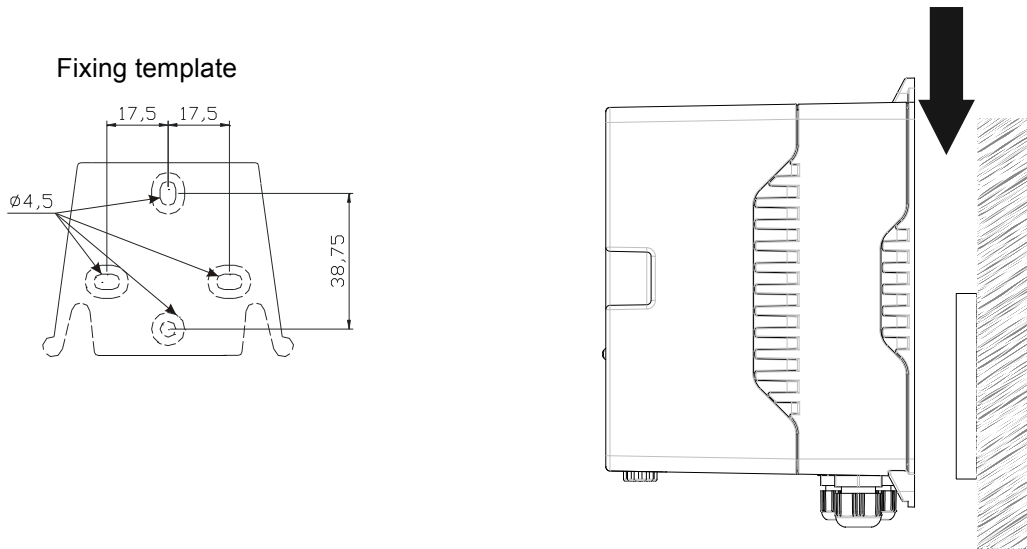

6. HYDRAULIC INSTALLATION

Mount the suction and discharge lines:

1. Cut off the ends of the hoses so that they are straight.
2. Screw on the cap nut and slide over the hose.
3. Screw in the hose end until it stops over the nozzle.
4. Connect the discharge line to the right- hand hose connection.
5. Connect the suction line to the left-hand hose connection.
6. Tighten up the cap nuts.
7. To do this, shorten the free end of the suction line so that the end hangs just above the container bottom.
8. If necessary, feed a hose line from the leakage fitting to the container.

7. ELECTRICAL INSTALLATION

1. Lay a power cable with short-circuit protection and mains switch - if necessary, with emergency stop switch.
2. Ensure that the mains power cable is dead and remains so!
3. Break out the small bore hole at the far right on the lower side of the back section by means of a screwdriver.
4. Screw in the corresponding screw and tighten up - not the scalping screw.
5. Insert the reducing inserts depending on the cable diameter being used and insert the threaded assembly.
6. Feed the mains cable into the threaded assembly.
7. Connect the mains cable to terminal block.
8. Tighten up the clamping screw so that the threaded assembly is moisture-proof.

6.1 Electrical Connections

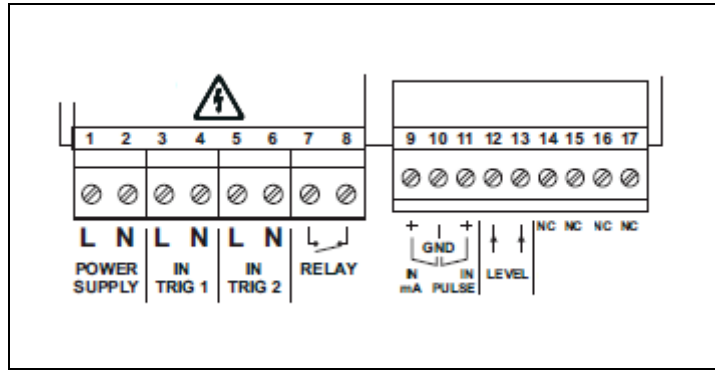

Terminal number	Description	Electrical features	
1 - 2	Power supply	100÷240 VAC (50–60Hz)	
3 - 4	Trigger 1 input signal	24÷240 VAC or VDC	
5 - 6	Trigger 2 input signal	24÷240 VAC or VDC	
7 - 8	Alarm relay output	250VAC 8A	
9 - 10	9 Pole + (mA)	Input mA	0/4÷20 mA (Input impedance: 200 ohm)
	10 Pole - (GND)		
10 - 11	10 Pole - (GND)	Pulses input	Pulses free from voltage (pulse emission meter; dry contact: on-off, maximum frequency 1KHz)
	11 Pole + (Pulse)		
12 - 13	Level control probe input	Dry contact (on-off)	
14 -15 -16 -17	Not used	Not used	

8. OPERATING UNIT

8.1 Control Keys





The control keys are designated as follows:

Key	Description
	Starts and stops the pump. In the event of a level alarm (alarm function only), flow alarm and active memory alarm, it deactivates the signal on the display.
	Used to “exit” the various menu levels. Before definitively exiting the programming phase, you will be asked if you wish to save any changes.
	When pressed during the pump operation phase, it cyclically displays the programmed values on the display. When pressed at the same time or keys, it increases or decreases a value dependent on the selected operating mode. During programming it carries out an “enter” function, meaning that it confirms entry to the various menu levels and modifications within the same.
	Used to run upwards through the menu
	Used to run downwards through the menu or for the priming, keeping it there for at least 3 seconds, pump start running at 100% until the key is pressed.
	Used to increase the numerical values to be changed. Can be used to start dosage in Batch mode.
	Used to decrease the numerical values to be changed.





8.2 Programming menu

You can access the programming menu by pressing the  key.

The   keys can be used to run through the menu items, with the  key being used to access changes.

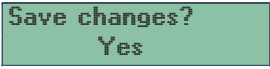

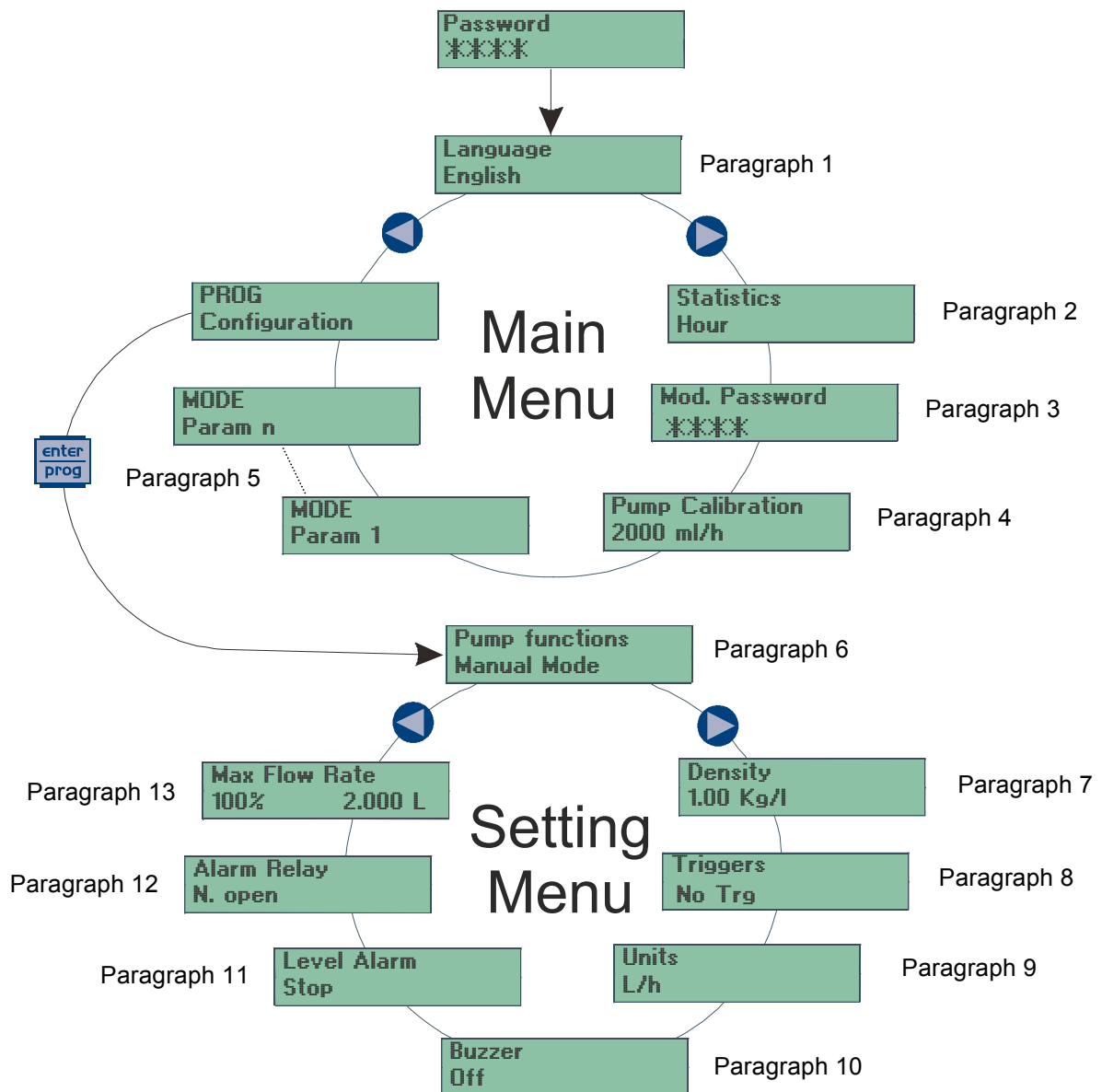

The pump is programmed in constant mode in the factory. The pump automatically returns to the operating mode after 1 minute of no activity. Any data entered in these circumstances will not be saved.

The  key can be used to exit the various programming levels. Upon exiting programming, the display will show:





    to confirm the selection.







Paragraph 1

Programming	Operation
<div data-bbox="331 286 603 349" style="border: 1px solid black; padding: 5px; background-color: #d9ead3;"> Language English </div>	<p>Makes it possible to select the language. The pump is set in English in the factory.</p> <p>Changes can be made by pressing the  key, then using the   keys to set the new value.</p> <p>Press  to confirm and return to the main menu.</p>





Paragraph 2

Programming	Operation
<div data-bbox="331 707 603 770" style="border: 1px solid black; padding: 5px; background-color: #d9ead3;"> Statistics Hour </div>	<p>The main menu displays the pump operation times. By pressing the  key you can access other statistics:</p> <ul style="list-style-type: none"> - Tubing hours = tubing operation times. - Q.ty (liters) = quantity dosed by the pump in liters. - Reset = use the   to reset the counters (YES) or otherwise (NO), then confirm by pressing the  key. <p>Pressing the  key will take you back to the main menu.</p>

Paragraph 3

Programming	Operation
<div data-bbox="331 1319 603 1382" style="border: 1px solid black; padding: 5px; background-color: #d9ead3;"> Mod. Password **** </div>	<p>Makes it possible to change the access password. Changes can be made by pressing the  key, then using the   keys to set the new value.</p> <p>To disable the password, enter the value 0000.</p> <p>Pressing the  key will take you back to the main menu.</p>

Paragraph 4

Programming	Operation
<div data-bbox="331 1839 603 1901" style="border: 1px solid black; padding: 5px; background-color: #d9ead3;"> Calibration 2000 ml/h </div>	<p>The pump can be calibrated as follow:</p> <p>the pump run at the maximum speed for 36 sec (version 10 l/h) or 180 sec (version 2 l/h) , which is started by pressing the  key.</p> <p>At the end of this time, enter the quantity sucked up by the pump using the   keys and confirm by pressing the  key.</p> <p>The entered figure will be used in flow calculations.</p>

Paragraph 5

PROG
Configuration



Pump function
Manual Mode

menu

These items menu are different depending on the settings:

- **Manual Mode**
- **mA Mode**
- **PPM Mode**
- **1:N Mode**
- **N:1 Mode**
- **Batch Mode**



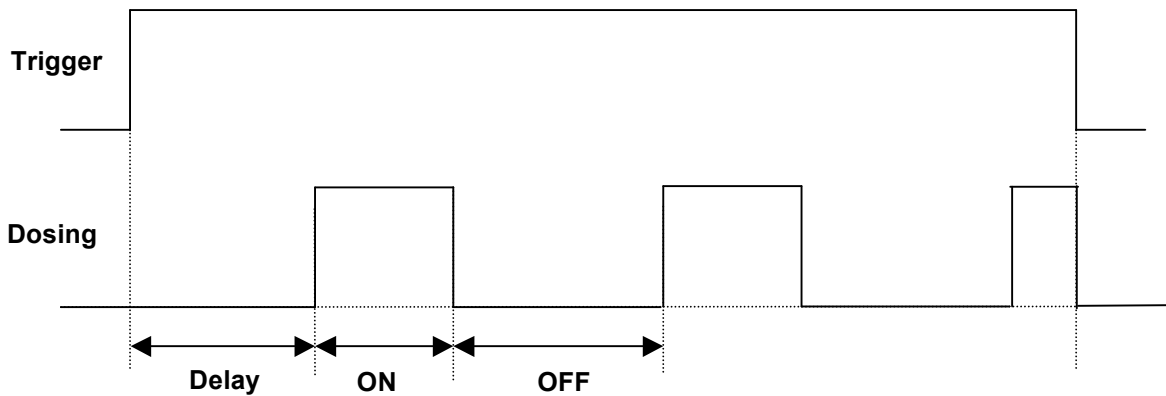

Case Manual Mode:

Pump doses at selected flow rate. If OFF Time is set to 0sec, pump runs continuously. Pump start dosing after a selectable Delay time.

Ex. Manual Dosing with trigger:



If no trigger is selected, pump start delay counting after power-on.

Programming	Operation
<div style="text-align: center;"> <div data-bbox="331 1384 603 1451" style="border: 1px solid black; padding: 5px; margin-bottom: 10px;">Manual MODE ON Time sec</div> <div style="text-align: center;">↓</div> <div data-bbox="331 1547 603 1615" style="border: 1px solid black; padding: 5px; margin-bottom: 10px;">Manual MODE OFF Time sec</div> <div style="text-align: center;">↓</div> <div data-bbox="331 1711 603 1778" style="border: 1px solid black; padding: 5px;">Manual MODE DELAY Time sec</div> </div>	<p>The pump operates in constant mode. The flow can only be manually regulated by pressing the   keys at the same time to increase the flow, or the   keys to decrease it.</p> <p>Makes it possible to set:</p> <ul style="list-style-type: none"> • ON Time= Time for which the pump runs. • OFF Time= Time for which the pump is stopped. • DELAY Time= time delay after which the pump starts to run.

Case mA Mode:

The pump proportionally doses to a signal of (0)4-20 mA or 20-4(0) mA. Is possible to set the mA input value corresponding to 0% dosing and the mA input value corresponding to the pump maximum flow rate.

Ex. **Direct** mA dosing:

mA input for 0% = 5mA

mA input for MAX FLOW RATE = 10mA

Max flow rate = 80%

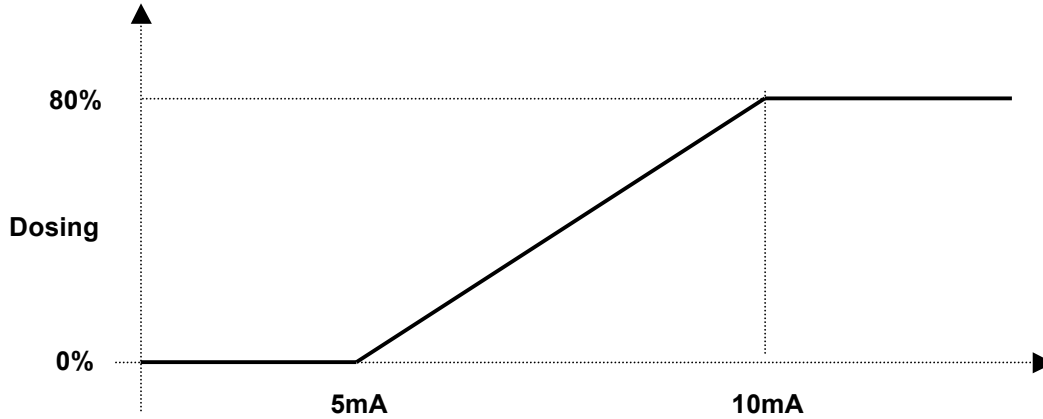



Ex. **Invers** mA dosing:

mA input for 0% = 10mA

mA input for MAX FLOW RATE = 5mA

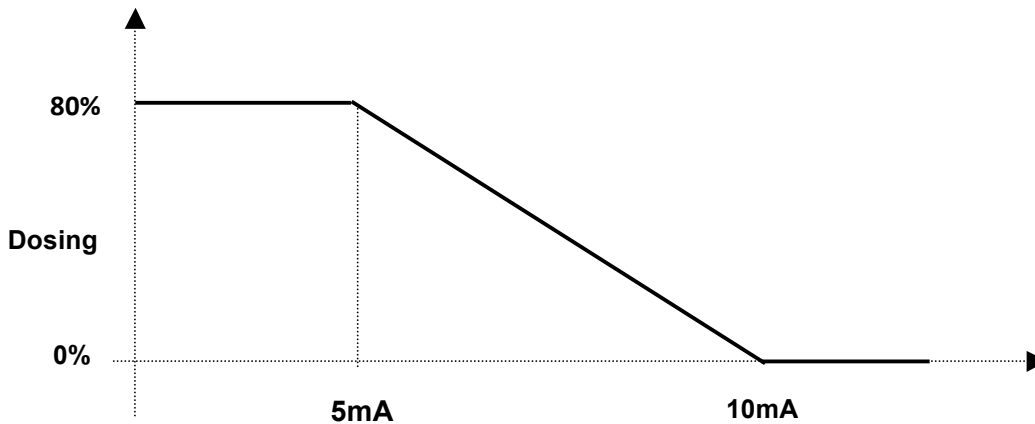
Max flow rate = 80%





Programming	Operation
<div style="text-align: center;"> <div style="border: 1px solid black; background-color: #d9ead3; padding: 5px; width: fit-content; margin: 0 auto;">mA MODE MAX DOS @ 20.0mA</div> <div style="text-align: center; margin: 10px 0;">↓</div> <div style="border: 1px solid black; background-color: #d9ead3; padding: 5px; width: fit-content; margin: 0 auto;">mA MODE 0% DOS @ 04.0mA</div> </div>	<p>The pump proportionally doses at a signal of 0/4-20 mA. On the basis of the factory settings, the pump interrupts dosage at 0mA and doses at the maximum set frequency when it receives 20 mA. These two values can be modified during programming. The maximum and the minimum frequency can be modified during operation, by pressing the  keys at the same time to increase the flow, or the  keys to decrease it.</p>

Case PPM Mode:

In order to maintain the selected ppm of chemical, The pump calculates the right dosing rate starting from the following parameters:

- Pulse per minute on pulse input
- Flowmeter factor (pulse/liter)
- Density of chemical
- Concentration of chemical

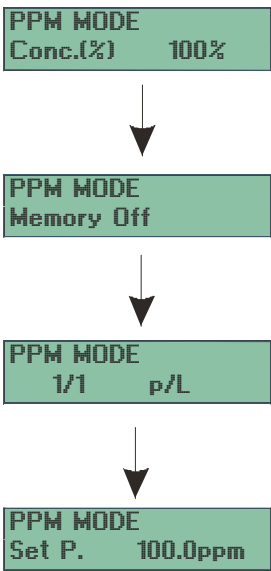
If calculated flow rate is bigger than maximum, the pump goes in MEM function (if selected) and doses the lasting quantity when possible.

Programming	Operation
 <pre> graph TD A["PPM MODE Conc.(%) 100%"] --> B["PPM MODE Memory Off"] B --> C["PPM MODE 1/1 p/L"] C --> D["PPM MODE Set P. 100.0ppm"] </pre>	<p>The pump doses in proportion to an external signal (i.e.: impulse launch counter), automatically calculating the relationship between incoming signals and pump speed on the basis of the programmed ppm value.</p> <p>The dosage frequency can be modified during operation, by pressing the  keys at the same time to increase the flow, or the  keys to decrease it.</p> <p>Makes it possible to set:</p> <ul style="list-style-type: none"> • Conc.(%)= product concentration. • Memory= The pump has a memory function, which signals the reception of a signal during dosage. If set to Off, it merely sends a signal, if set to On it sends a signal and memorizes the impulses, then executes them when it has finished receiving signals • 1/1= number of impulses per liters (1/1-999/999) and consequently the system will dose according to the values set. • Set P.= ppm value that the system will dose.

Case 1:N Mode:



Pump doses following pulses number to the related input.
One input pulse generate 1 second of dosing at set speed (N)
e.g.

- If N is set to 1 (N=1), pump doses for one second at speed=1% of Max speed
- If N is set to 100 (N=100), pump doses for one second at speed=100% (Max speed)

version	Average Dosing @ 1%*	Average Dosing @ 100%*
10000ml/h	0.027ml	2.77ml
2000ml/h	0.0055ml	0.55ml

* quantity dosed in 1 second

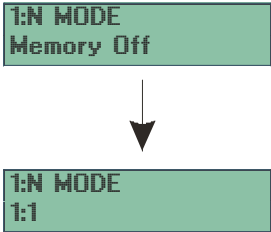
If calculated flow rate is bigger than maximum, the pump goes in MEM function (if selected) and doses the lasting quantity when possible.

Programming	Operation
<div style="text-align: center;">  <p>The diagram shows two green boxes. The top box contains '1:N MODE' and 'Memory Off'. An arrow points down to the second box, which contains '1:N MODE' and '1:1'.</p> </div>	<p>The pump doses in proportion to an external signal (i.e.: impulse launch counter). With every signal received, the pump makes 1 second at the programmed “N” (i.e.: 20%) speed.</p> <p>The value of “N” can be modified during operation, by pressing the  keys at the same time to increase the flow, or the  keys to decrease it. Makes it possible to set:</p> <ul style="list-style-type: none"> • Memory= The pump has a memory function, which signals the reception of a signal during dosage. If set to Off, it merely sends a signal, if set to On it sends a signal and memorizes the impulses, then executes them when it has finished receiving signals • 1:N= With every signal received, the pump makes 1 second at the programmed “N” (i.e.: 20%) speed.

Case N:1 Mode:



Pump doses following pulses number to the related input.
N input pulses generate 1 second of dosing at 1%
e.g.

- If N is set to 1 (N=1), pump doses for one second at speed=1% of Max speed
- If N is set to 100 (N=100), pump waits for 100 pulses than doses for one second at speed=1% of Max speed

version	Average Dosing @ 1%*	Average Dosing @ 100%*
10000ml/h	0.027ml	2.77ml
2000ml/h	0.0055ml	0.55ml

* quantity dosed in 1 second

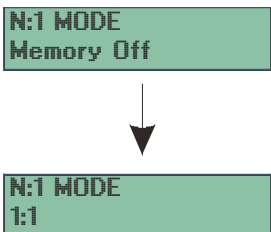





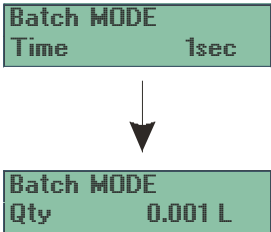

If calculated flow rate is bigger than maximum, the pump goes in MEM function (if selected) and doses the lasting quantity when possible.

Programming	Operation
<div style="text-align: center;">  <p>The diagram shows two green boxes. The top box contains 'N:1 MODE' and 'Memory Off'. An arrow points down to the second box, which contains 'N:1 MODE' and '1:1'.</p> </div>	<p>The pump doses in proportion to an external signal (i.e.: impulse launch counter). With every programmed “N” signal received, the pump makes 1 second at the 1% of max speed.</p> <p>The value of “N” can be modified during operation, by pressing the  keys at the same time to increase the flow, or the  keys to decrease it. Makes it possible to set:</p> <ul style="list-style-type: none"> • Memory= The pump has a memory function, which signals the reception of a signal during dosage. If set to Off, it merely sends a signal, if set to On it sends a signal and memorizes the impulses, then executes them when it has finished receiving signals • N:1= With every programmed “N” signal received, the pump makes 1 second at the 1% of max speed.

Case Batch Mode:

Pump doses the selected quantity when UP button is pressed or when a pulse is read on input (other pulses are ignored when pump is dosing) or if trigger/s signals are selected, when a valid trigger/s signals is read on input.

If time selected for dosing is too short, pump doses at the maximum flow rate.

Programming	Operation
	<p>The pump doses in proportion to an external signal (i.e.: impulse launch counter). In this case, it is possible to set the quantity to be dosed in l and the time within which to complete dosage.</p> <p>Dosage can be started manually by pressing the  key, or by using a remote control. The  key interrupts dosage. The dosage already made can be reset by pressing the  key, or started again by pressing the  key again.</p> <p>The quantity to be dosed can be modified during operation, by pressing the   keys at the same time to increase the flow, or the   keys to decrease.</p> <p>Makes it possible to set:</p> <ul style="list-style-type: none"> • Time= the time within which to complete dosage in second • Qty= the quantity to be dosed in liter

Paragraph 6

Makes it possible to set the Pump Functions as follow:

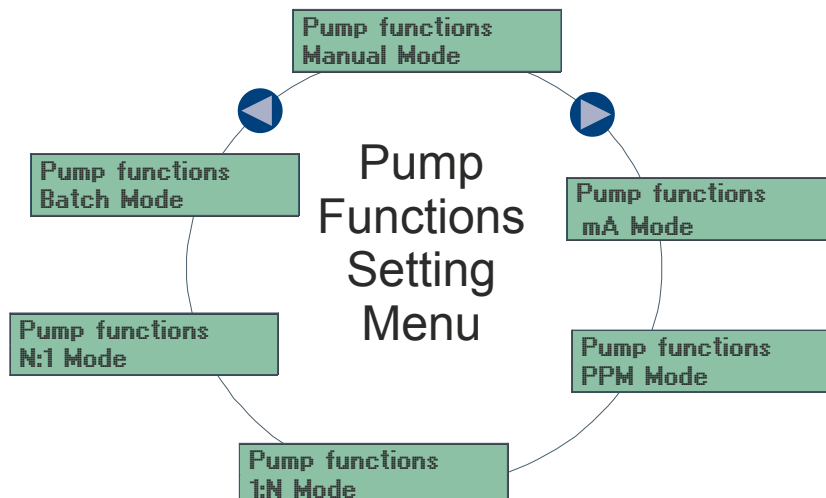

Paragraph 7

Programming	Operation
<div data-bbox="331 286 603 349" style="border: 1px solid black; background-color: #d9ead3; padding: 5px; width: fit-content;"> Density 1.00 kg/L </div>	This makes it possible to set the density of the chemical product.

Paragraph 8

Programming	Operation
<div data-bbox="331 696 603 759" style="border: 1px solid black; background-color: #d9ead3; padding: 5px; width: fit-content;"> Triggers No Trg </div>	This makes it possible to set the input triggers. When the triggers are present, gives consent to the pump to run, depending the setting pump function: <ul style="list-style-type: none"> • No Trg= the triggers are disabled. • Trg 1= the pump run when only the trigger 1 is enabled. • Trg 2= the pump run when only the trigger 2 is enabled. • Trg 1&2= the pump run when the both triggers (1&2) are enabled.

Paragraph 9

Programming	Operation
<div data-bbox="331 1294 603 1357" style="border: 1px solid black; background-color: #d9ead3; padding: 5px; width: fit-content;"> Units L/h </div>	This makes it possible to set unit of measurement, which can be: <ul style="list-style-type: none"> • L/h= liter per hour. • ml/m= milliliter per minute. • Gph= Gallon per hour. • %= the percentage of the maximum flow-rate.

Paragraph 10

Programming	Operation
<div data-bbox="331 1684 603 1747" style="border: 1px solid black; background-color: #d9ead3; padding: 5px; width: fit-content;"> Buzzer Off </div>	The buzzer is active when there is an alarm condition. This makes it possible to set the buzzer the system to On or Off.

Paragraph 11

Programming	Operation
<div data-bbox="331 1930 603 1993" style="border: 1px solid black; background-color: #d9ead3; padding: 5px; width: fit-content;"> Level Alarm Stop </div>	This makes it possible to set the level alarm as follow: <ul style="list-style-type: none"> • Stop= the pump stops. • Run= the pump keeps running.

Paragraph 12



Programming	Operation
<div style="border: 1px solid black; padding: 5px; width: fit-content; margin: auto;"> Alarm Relay N.Open </div>	This makes it possible to set the alarm relay as follow: <ul style="list-style-type: none"> • N.Open= normally open. • N.Closed= normally closed.



Paragraph 13

Programming	Operation
<div style="border: 1px solid black; padding: 5px; width: fit-content; margin: auto;"> Max Flow Rate 100% 10.000 L </div>	This makes it possible to set the maximum flow offered by the pump, and the programmed mode (% or frequency) is used as the standard unit of measurement when displaying the flow.



9. Maintenance

9.1 Tubing change

With the pump in **Stop** (press the  key), by pressing the  key for at least 3 seconds the pump run anticlockwise at the minimum speed in order to facilitate the removing hose, to terminate the running pump press the  key.

With the same procedure, by pressing the  key for at least 3 seconds the pump run clockwise at the minimum speed in order to facilitate the replacing hose, to terminate the running pump press the  key.

9.2 LCD Contrast

With the pump in **Stop** (press the  key), by pressing the  and  keys to increase or decrease the contrast.

10. Display view

10.1 During the dosage

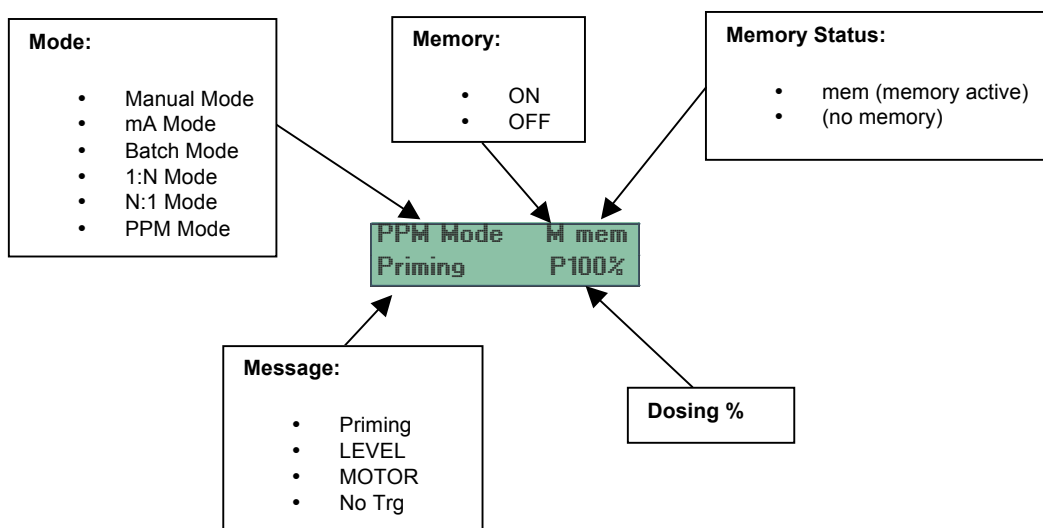

10.2 During the Stop

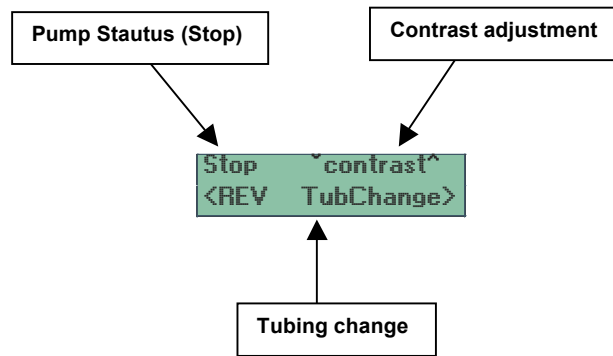

11. QUICK PARAMETER SETTING

From dosing visualization mode, by pressing for at least 3 seconds the  key, the display will show the quick setting menu:

```
Manual Mode
Max %      100%
```

In this menu you can change the following items:

1) Max Flow Rate in:

- mA Mode
- Manual Mode

2) N in:



- 1:N Mode
- N:1 Mode

3) Quantity in:

- Batch Mode

4) ppm in

- ppm Mode

To modify the current value keeping pressed the  with  or  keys.

12. Parameter List

	Parameter	Value	Value	Value	Value	Value	Value	Default
1	Language	english	german	italian				english
2	Password	0 - 9999						0 (disabled)
3	Statistics	dosing hours	tubing hours	liters				
4	Max flow rate	0.1 – 100.0%						100.0%
5	Pump Function	Manual Mode	mA Mode	Batch Mode	1 :N Mode	N :1 Mode	Ppm Mode	Manual Mode
6	Alarm Relay	N. Open	N.Closed					N.Open
7	Level Alarm	Stop	Run					Stop
8	Buzzer	ON	OFF					OFF
9	Unit	ml/h	L/h	%				ml/h
10	Trigger	No Trg	Trg 1	Trg 2	Trg 1&2			No Trg
11	Density	0.50-2.00						1.00
12	On Time	0-10000						10
13	Off Time	0-10000						0
14	Delay Time	0-10000						0
15	mA for 0%	0.0-20.0						4.0
16	mA for max	0.0-20.0						20.0
17	N	1-1000						1
18	pulse	1-2000						1
19	liter	1-2000						1
20	Chem. Conc.	1-100						100
21	ppm	0-3000						1000
22	memory	ON	OFF					OFF
23	quantity	0-30000						1
24	time	0-10000						1
25	Flow rate	Calibr.						10000

13. Dosing parameter Table

Mode	Param 1	Param 2	Param 3	Memory	Trigger	Max flow rate	Density
Manual	ON Time sec <u>(0-10000)</u>	OFF Time sec <u>(0-10000)</u>	DELAY Time sec <u>(0-10000)</u>		TRIGGER <u>(No Trg/Trg 1/Trg 2/Trg 1&2)</u>	MAX FLOW RATE <u>(0.1 –100%)</u>	
Direct or Inverse mA	mA Input for min dosing <u>(0.0-20.0 mA)</u>	mA Input for max dosing <u>(0.0-20.0 mA)</u>			TRIGGER <u>(No Trg/Trg 1/Trg 2/Trg 1&2)</u>	MAX FLOW RATE <u>(0.1 –100%)</u>	
PPM	Set Point <u>(1-3000 ppm)</u>	Flowmeter factor <u>(1-2000 pul / 1-2000 Lit)</u>	CHEM. CONC. <u>(1-100%)</u>	MEMORY <u>(ON-OFF)</u>	TRIGGER <u>(No Trg/Trg 1/Trg 2/Trg 1&2)</u>		DENSITY <u>(0.50 – 2.00 kg/L)</u> <u>1.00</u>
Batch	Quantity <u>(1-30000ml)</u>	Time sec <u>(1-10000)</u>		MEMORY <u>(ON-OFF)</u>			DENSITY <u>(0.50 – 2.00 kg/L)</u> <u>1.00</u>
PROP 1:N	N <u>(1-1000)</u>			MEMORY <u>(ON-OFF)</u>	TRIGGER <u>(No Trg/Trg 1/Trg 2/Trg 1&2)</u>		
PROP N:1	N <u>(1-1000)</u>			MEMORY <u>(ON-OFF)</u>	TRIGGER <u>(No Trg/Trg 1/Trg 2/Trg 1&2)</u>		

Default parameters are typed bold and underlined

14. Alarms Table

alarm	dosing	Display	buzzer	Relay
Tube Break	stop	TUBE BREAK	ON if selected	ON if selected
Level	Stop if selected	LEVEL	ON if selected	ON if selected
Motor	stop	MOTOR	ON if selected	ON if selected

1. SICHERHEITSINFORMATIONEN

Erklärung der Sicherheitsinformationen.



Warnung – Hochspannung



Warnung – heiße Oberfläche



Warnung – Gefahrenbereich

Korrekter und sachgemäßer Gebrauch

- Diese Pumpe darf ausschließlich als Dosierpumpe für Flüssigchemikalien verwendet werden.
- Das System darf ausschließlich in Übereinstimmung mit den in der Bedienungsanleitung aufgeführten technischen Daten und Spezifikationen verwendet werden.
- Die Pumpe darf ausschließlich nach korrekter Installation und Betriebsprüfung verwendet werden.
- Jeder weitere Gebrauch und Veränderungen sind untersagt.
- Die Pumpe darf nicht als Dosierpumpe von Gasen oder Feststoffen verwendet werden.
- Die Pumpe ist ohne entsprechende Schutzausrüstung (Abdeckung, wetterfeste Überdachung) nicht für die Außenaufstellung geeignet.
- Die Pumpe sollte ausschließlich von entsprechend geschultem und befugtem Personal bedient werden, siehe nachstehende Übersicht.
- Sie sind zur Einhaltung der in der Bedienungsanleitung genannten Maßnahmen zu den verschiedenen Wartungsabschnitten des Systems verpflichtet.

Fachpersonal

Unter qualifiziertem Personal versteht man eine Person, die in der Lage ist, die ihr aufgetragenen Aufgaben auszuführen und mögliche Gefahren aufgrund ihrer technischen Ausbildung und Erfahrung sowie ihres Wissens zu erkennen und die alle einschlägigen Vorschriften kennt.

Elektriker

Unter Elektriker versteht man eine Person, die in der Lage ist, Arbeiten an Elektroanlagen auszuführen und mögliche Gefahren aufgrund ihrer technischen Ausbildung und Erfahrung sowie ihres Wissens zu vermeiden und die alle einschlägigen Vorschriften kennt. Elektriker sollten eine speziell für ihren Einsatzort bestimmte Schulung vorweisen und alle einschlägigen Normen und Vorschriften kennen. Elektriker müssen die Vorgaben der anwendbaren Richtlinien zur Unfallvermeidung erfüllen.

Angewiesenes Personal

Unter angewiesenem Personal versteht man eine Person, die in die im aufgetragene(n) Aufgabe(n) eingewiesen und ggf. entsprechend geschult wurde und über mögliche Gefahren infolge unsachgemäßen Verhaltens aufgeklärt wurde. Sie wurde des Weiteren über die erforderliche Schutzausrüstung und Schutzmaßnahmen aufgeklärt.

Schutzausrüstung

Die durchsichtige Abdeckung am Ende der Leitung dient als Schutz vor der Berührung des Drehkreuzes und verhindert ein Austreten des Mediums im Falle eines Schlauchbruchs.

Verhalten im Notfall

Im Notfall den Netzstecker ziehen oder eine der Not-Aus-Tasten, falls vorhanden, betätigen.

Falls Chemikalien austreten ebenso den Druck aus dem Leitungssystem um die Pumpe ablassen. In Bezug auf die Chemikalien siehe Sicherheitsdatenblatt.

2. INFORMATIONEN ÜBER DAS PRODUKT

Kronos ist eine peristaltische Dosierpumpe mit Schrittmotorantrieb. Die Chemikalie wird durch ein Drehkreuz befördert, das auf den Schlauch drückt. Dazu sind keine Ventile erforderlich. Dadurch wird ein behutsamer Umgang mit dem Dosiermedium gewährleistet.

Zu den typischen Anwendungsgebieten zählen Prozesse mit niedrigem Enddruck, wie beispielsweise die der Dosierung von Chemikalien für galvanische Bäder, Klärtanks oder zur Dosierung von Aufbereitungsmitteln für Schwimmbäder (Flockmittel, Aktivkohle und Chemikalien).

Das Gehäuse besteht aus stoßfestem und chemikalienbeständigem PEE, Schutzgrad IP65.

Es verfügt über mehrere Eingänge zur Einstellung der Dosierung. Durch den Schrittmotor ist die Dosierung unbegrenzt verstellbar.

Nachstehend eine Übersicht der wichtigsten Merkmale:

- Stromversorgung 100÷240 Vac 50/60 Hz
- Leistungsbereich: 0.010 ÷ 10.00 l/h @ 2bar oder 0.002 ÷ 02.00 l/h @ 3bar
 - 0.010 ÷ 10.00 l/h @ 2bar or 0.002 ÷ 02.00 l/h @ 3bar
 - Schlauchmaterial SekoExtra or SekoMed (andere auf Anfrage)
 - 0.008 ÷ 8.00 l/h @ 3bar or 0.003 ÷ 03.00 l/h @ 6bar
 - Schlauchmaterial SekoTech
- Leistungsstarker Schrittmotor mit verstellbarer Drehzahl
- Unbegrenzte Verstellung und Regelung der Dosiermengen, entweder manuell oder extern über 0/4-20 mA Signale
- Priming-Funktion (Hochgeschwindigkeitsbetrieb)
- Anzeige der Dosierungsleistung auf dem Display in l/h, ml/m, Gph oder %
- Umkehrbare Laufrichtung
- Gehäuse Schutzgrad IP 65
- Schlauchbruchsystem
- 1,6A Schmelzsicherung (20W)

3. ABMESSUNGEN UND GERÄTEANSICHT

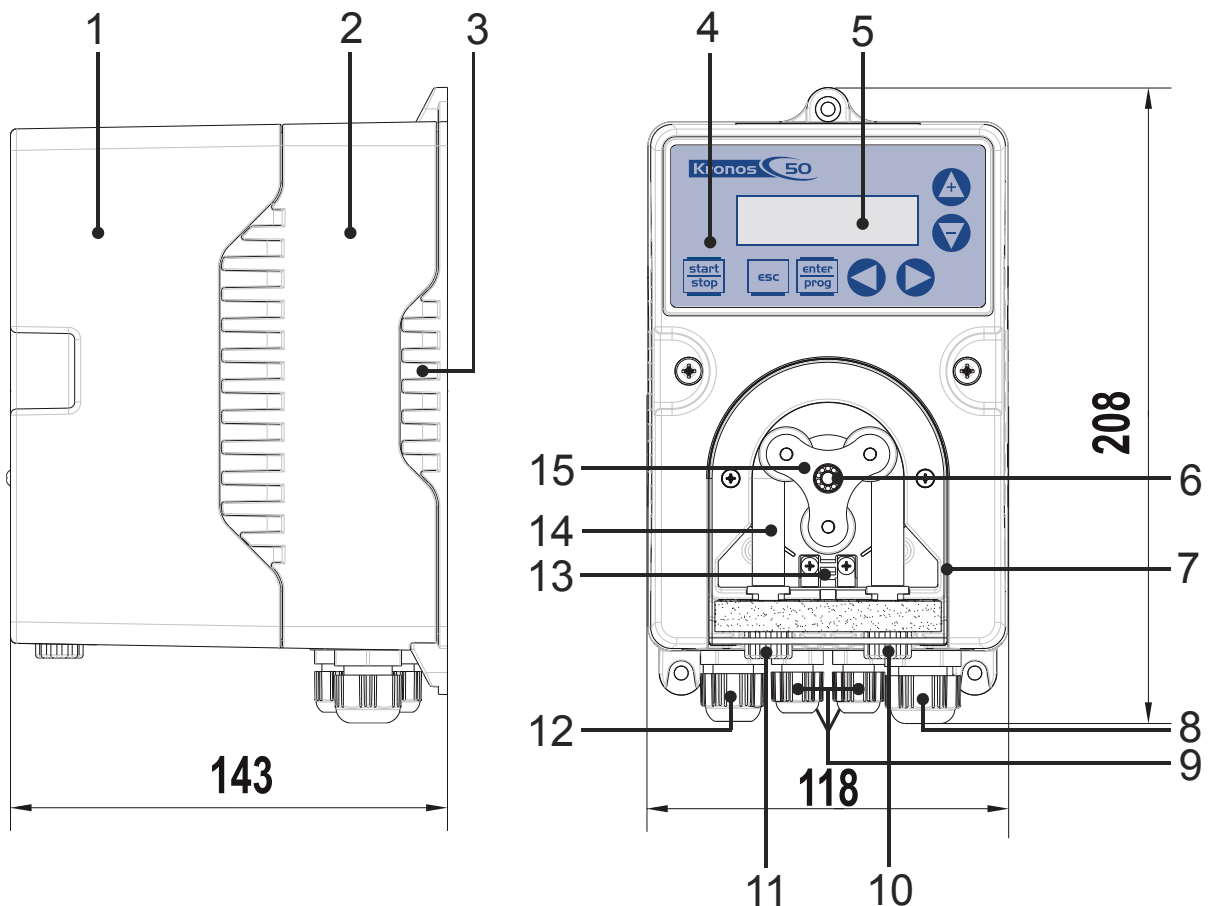

1	Gehäuse obere Einheit	9	PCBs 7
2	Gehäuse zentrale Einheit	10	Druckanschluss
3	Gehäuse untere Einheit	11	Sauganschluss
4	Bedienelemente	12	PCB 9
5	LCD-Display	13	Schlauchbruchsensor
6	Kugellager	14	Pumpenschlauch
7	Transparente Schutzabdeckung	15	Drehkreuz
8	PCB 11		

4. AUFBAU UND FUNKTIONSBESCHREIBUNG

Die Pumpe besteht aus zwei Hauptkomponenten:

- Antrieb (Schrittmotor)
- Flüssigkeitsende (Drehkreuz, Rollen und Pumpenschlauch)

Betriebseinheit

Das Gerät ist in einem robusten Plastikgehäuse untergebracht. Das Plastikgehäuse besteht aus oberen und unteren Bauteilen, die zusammengeschraubt sind. Im unteren Bereich sitzen die PCBs für den Stromanschluss und die weiteren Anschlüsse.

Im oberen Bereich des Gehäuses sind die CPU, der Motor und das PCB Display mit Bildschirm und Bedienelementen untergebracht.

Das Flüssigkeitsende ist vorderseitig montiert, eine angeschraubte transparente Schutzabdeckung schützt vor Unfällen und Verletzungen. Der Pumpenschlauch kann nach der Entfernung der transparenten Abdeckung problemlos ausgewechselt werden.

Durch die Drehbewegung des Drehkreuzes wird der Pumpenschlauch über drei Rollen abwechselnd gequetscht und gelöst. Folglich wird die Flüssigkeit angesaugt und durch den Druckschlauch befördert.

Die Pumpe wird über ein Bedienpult gesteuert. Die gewünschte Dosiermenge und der Dosiermodus werden über das Bedienpult konfiguriert. Die Dosierung wird über das Bedienpult oder einen externen Kontakt überwacht.

5. INSTALLATION

1. Markieren Sie die Bohrlöcher an der Wand
2. Ø 8 mm Löcher bohren und die beiliegenden Dübel einsetzen
3. Halterung an der Wand befestigen
4. Gerät an der Oberseite einsetzen

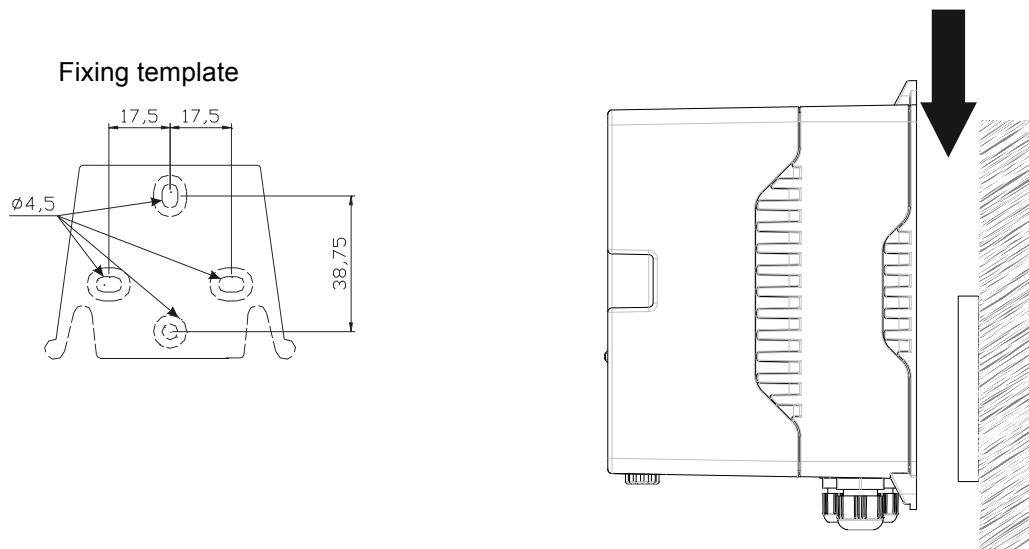

6. LEITUNGSANSCHLUSS

Installation der Saug- und Druckleitungen:

1. Schneiden Sie zunächst die Enden des Schlauches gerade ab.
2. Die Kappe anschrauben und über den Schlauch ziehen.
3. Schlauch hineinschrauben, bis er über der Tülle sitzt.
4. Verbinden Sie die Druckleitung mit dem rechten Schlauchanschluss.
5. Verbinden Sie die Saugleitung mit dem linken Schlauchanschluss.
6. Kappen festziehen.
7. Dazu das freiliegende Ende der Saugleitung so verkürzen, dass das Ende direkt über der Unterseite des Behälters hängt.
8. Gegebenenfalls eine Schlauchleitung vom Eintrittsanschluss zum Behälter verlegen.

7. STROMANSCHLUSS

1. Ein Stromkabel mit Kurzschlusschutz und Netzschalter, ggf. auch mit Not-Aus-Schalter, verlegen.
2. Sicherstellen, dass das Stromkabel vollkommen spannungsfrei ist und das auch bleibt.
3. Mit einem Schraubenzieher die kleine Bohrung ganz rechts außen im unteren Bereich an der Geräterückseite durchbrechen.
4. Die entsprechende Schraube einsetzen und festziehen.
5. Je nach Kabeldurchmesser geeignete Reduzierstücke anbringen, dann das Gewindebauteil einsetzen.
6. Netzkabel durch das Gewindebauteil führen.
7. Netzkabel an der Klemmleiste anschließen.
8. Die Klemmschraube festziehen, so dass das Gewindebauteil vollkommen feuchtigkeitsbeständig ist.

6.1 Stromanschlüsse

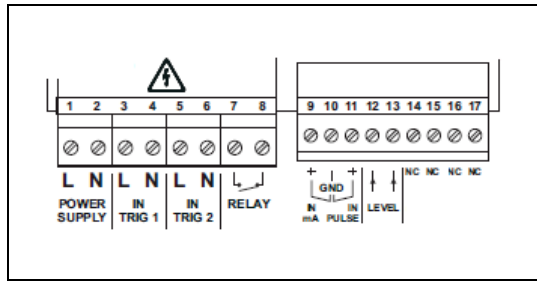

Klemmennummer	Beschreibung	Elektrische Merkmale	
1 - 2	Stromversorgung	100÷240 VAC (50–60Hz)	
3 - 4	Trigger 1 Eingangssignal	24÷240 VAC oder VDC	
5 - 6	Trigger 2 Eingangssignal	24÷240 VAC oder VDC	
7 - 8	Alarm Relaisausgang	250VAC 8A	
9 - 10	9 Pol + (mA)	Eingang mA	0/4÷20 mA (Eingangsimpedanz: 200 ohm)
	10 Pol - (GND)		
10 - 11	10 Pol - (GND)	Impulseingang	Spannungsfreie Impulse (Impulsmessung; Potentialfreier Kontakt) on-off, Höchstfrequenz 1KHz)
	11 Pol + (Impuls)		
12 - 13	Eingang Füllstandsonde	Potentialfreier Kontakt (on-off)	
14 -15 -16 -17	Nicht belegt	Nicht belegt	

8. BETRIEBSEINHEIT

8.1 Bedienelemente





Die Bedienelemente sind folgendermaßen gekennzeichnet:

Taste	Beschreibung
	Zum Starten und Stoppen der Pumpe. Im Falle eines Füllstandalarms (nur Alarmfunktion), Strömungsalarms und aktiven Speicheralarms wird das Signal am Display deaktiviert.
	Zum "Verlassen" der verschiedenen Menüstufen. Vor dem endgültigen Verlassen der Programmierung werden Sie gefragt, ob Sie die Änderungen speichern möchten.
	Bei Drücken dieser Taste während des Betriebs werden nacheinander die programmierten Werte auf dem Display angezeigt. Bei gleichzeitigem Drücken der Tasten oder wird ein Wert, je nach ausgewähltem Betriebsmodus, erhöht bzw. verringert. Während der Programmierung übernimmt diese Taste die Funktion "Enter", d.h. sie bestätigt des Zugriff auf die verschiedenen Menüstufen und die dort vorgenommenen Veränderungen.
	Menüdurchlauf nach oben
	Menüdurchlauf nach unten oder Priming-Funktion: Taste mindestens 3 Sekunden lang drücken, und die Pumpe nimmt den Betrieb bei 100% auf, solange die Taste gedrückt bleibt.
	Erhöht die numerischen Werte, die verändert werden sollen. Kann zum Starten der Dosierung im Batch Modus verwendet werden.
	Verringert die numerischen Werte, die verändert werden sollen.





8.2 Programmiermenü

Zum Zugriff auf das Programmiermenü Taste .

Die Tasten   werden zum Durchlaufen der Menüpunkte verwendet, mit der Taste  wird die zu bearbeitende Funktion ausgewählt.

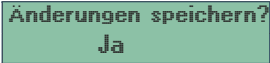

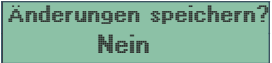

Die Pumpe ist werksseitig auf Dauerbetrieb eingestellt. Nach 1 Minute ohne Eingabe schaltet die Pumpe automatisch zurück auf Betriebsmodus. In diesem Fall werden die eingegebenen Daten nicht gespeichert.

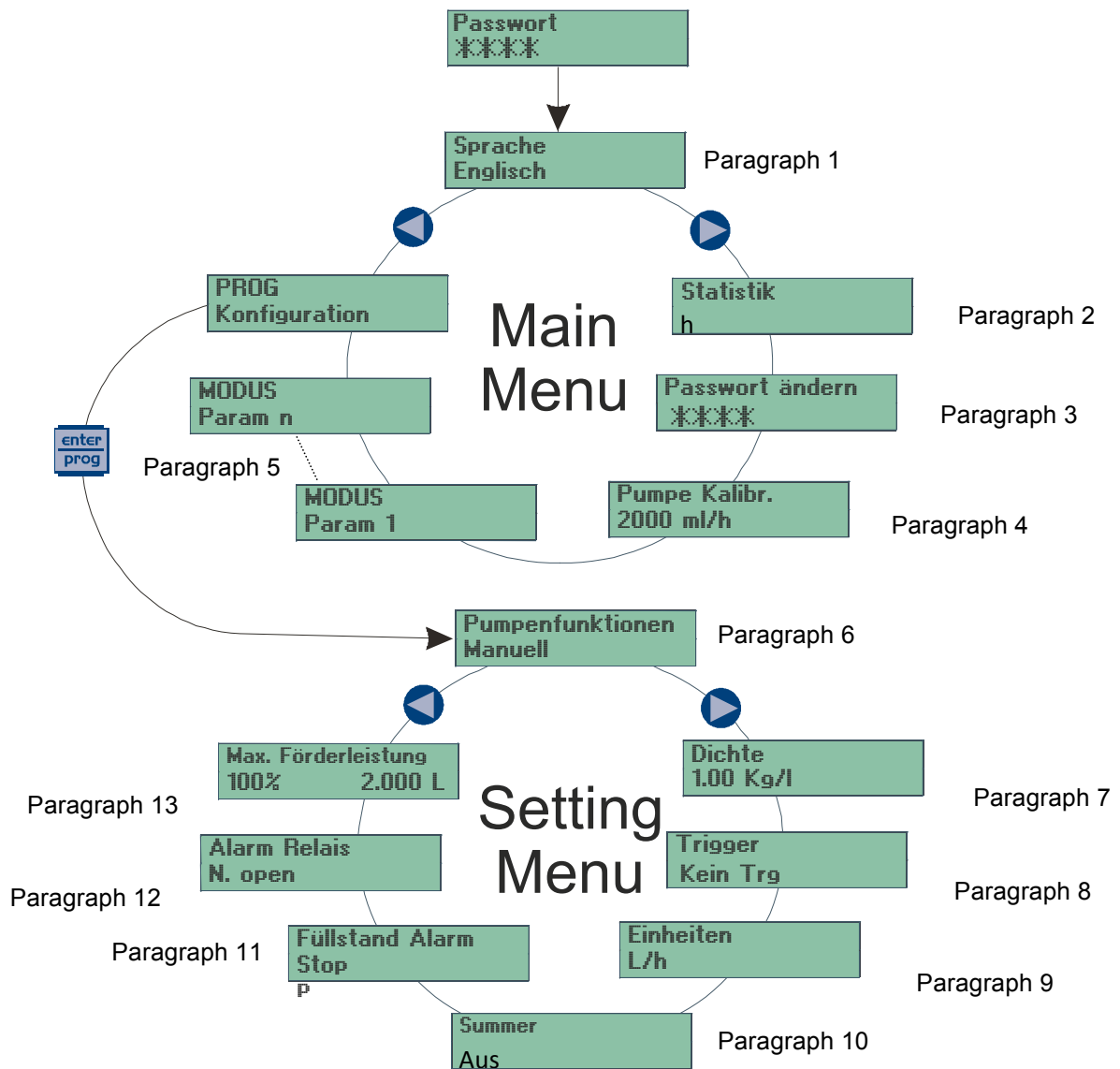
Mit der Taste  werden die verschiedenen Programmierstufen verlassen.
Nach dem Zugang zur Programmierung erscheint folgende Anzeige auf dem Display:





     zur Bestätigung.







Paragraph 1

Programmierung	Vorgang
<div style="border: 1px solid black; padding: 5px; width: fit-content; margin: 10px auto;"> Sprache Englisch </div>	<p>Möglichkeit zur Sprachwahl Werksseitige Einstellung auf Englisch</p> <p>Änderungen durch Drücken der Taste , dann die neuen Werte mit den Tasten   eingeben.</p> <p>Zur Bestätigung  drücken und zurück zum Hauptmenü.</p>





Paragraph 2

Programmierung	Vorgang
<div style="border: 1px solid black; padding: 5px; width: fit-content; margin: 10px auto;"> Statistik h </div>	<p>Auf dem Hauptmenü der Pumpe werden die Betriebszeiten angezeigt.</p> <p>Durch Drücken der Taste  haben Sie Zugriff zu weiteren Statistiken:</p> <ul style="list-style-type: none"> - Schlauch Stunden = Schlauch-Betriebszeiten. - Menge (Liter) = Von der Pumpe dosierte Menge in Litern. - Reset = Mit   werden die Betriebszähler zurückgestellt (JA) oder nicht (NEIN), dann mit  bestätigen. <p>Über die Taste  gelangt man zurück zum Hauptmenü.</p>

Paragraph 3

Programmierung	Vorgang
<div style="border: 1px solid black; padding: 5px; width: fit-content; margin: 10px auto;"> Passwort ändern **** </div>	<p>Möglichkeit zur Bearbeitung des Zugangspassworts.</p> <p>Änderungen durch Drücken der Taste , dann die neuen Werte mit den Tasten   eingeben.</p> <p>Zur Deaktivierung des Passworts 0000 eingeben.</p> <p>Über die Taste  gelangt man zurück zum Hauptmenü.</p>

Paragraph 4

Programmierung	Vorgang
<div style="border: 1px solid black; padding: 5px; width: fit-content; margin: 20px auto;"> Kalibrierung 2000 ml/h </div>	<p>Die Pumpe kann folgendermaßen kalibriert werden:</p> <p>Pumpe 36 Sekunden (Version 10 l/h) oder 180 Sekunden (Version 2 l/h) bei höchster Drehzahl laufen lassen, dazu Taste  drücken.</p> <p>Nach Ablauf dieser Zeit die von der Pumpe angezeigte Menge mit den Tasten   eingeben und mit Taste  bestätigen.</p> <p>Die Eingabe wird bei der Berechnung der Fördermenge berücksichtigt.</p>

Paragraph 5



Diese Menüs sind abhängig von den Einstellungen Menüeinstellungen:

- **Manuell**
- **mA Modus**
- **PPM Modus**
- **1:N Modus**
- **N:1 Modus**
- **Batch Modus**



Bei **manuellen Einstellungen**:

Pumpendosierung entspricht nicht der eingestellten Fördermenge. Falls AUS-Zeit auf 0 Sek gestellt ist, läuft die Pumpe im Dauerbetrieb.
Die Pumpe nimmt die Dosierung nach einer einstellbaren Verzögerung auf.

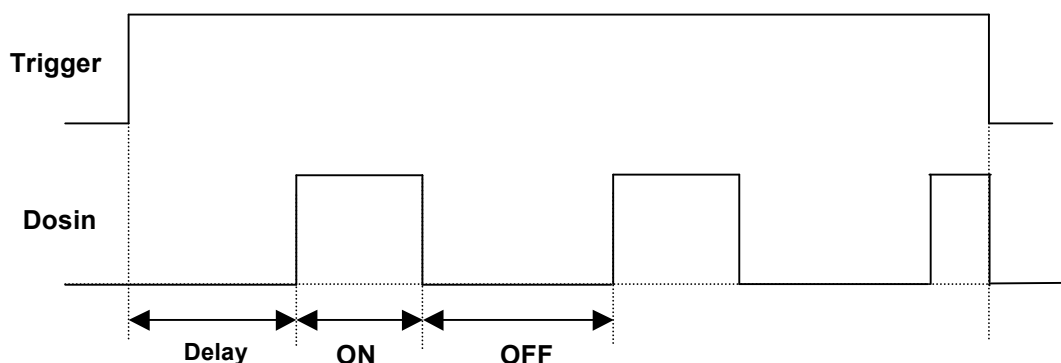
Beispiel: Manuelle Dosierung mit Trigger:



Ist kein Trigger ausgewarnt, beginnt die Pumpe nach dem Einschalten mit dem Countdown der Verzögerung.

Programmierung	Vorgang
<div style="text-align: center;"> <div style="border: 1px solid black; background-color: #d9ead3; padding: 5px; margin-bottom: 10px;">Manuell AN Zeit Sek</div> <div style="text-align: center;">↓</div> <div style="border: 1px solid black; background-color: #d9ead3; padding: 5px; margin-bottom: 10px;">Manuell AUS Zeit Sek</div> <div style="text-align: center;">↓</div> <div style="border: 1px solid black; background-color: #d9ead3; padding: 5px;">Manuell VERZÖGERUNG</div> </div>	<p>Die Pumpe läuft im Dauerbetrieb. Die Fördermenge kann nur manuell durch Drücken der Tasten  gesteigert, bzw. durch Drücken der Tasten  verringert werden.</p> <p>Mögliche Einstellungen:</p> <ul style="list-style-type: none"> • AN Zeit= Betriebszeit der Pumpe. • AUS Zeit= Stopzeit der Pumpe. • VERZÖGERUNG= Verzögerung, nach welche die Pumpe den Betrieb aufnimmt.

Bei mA Modus:

In diesem Modus dosiert die Pumpe proportional zu einem Signal zwischen (0)4-20 mA or 20-4(0) mA. Der mA Eingangswert kann auf 0% der Dosierung, der mA Eingangswert auf die maximale Förderleistung eingestellt werden.

Beispiel: **Direkte** mA Dosierung:

mA Eingang 0% = 5mA

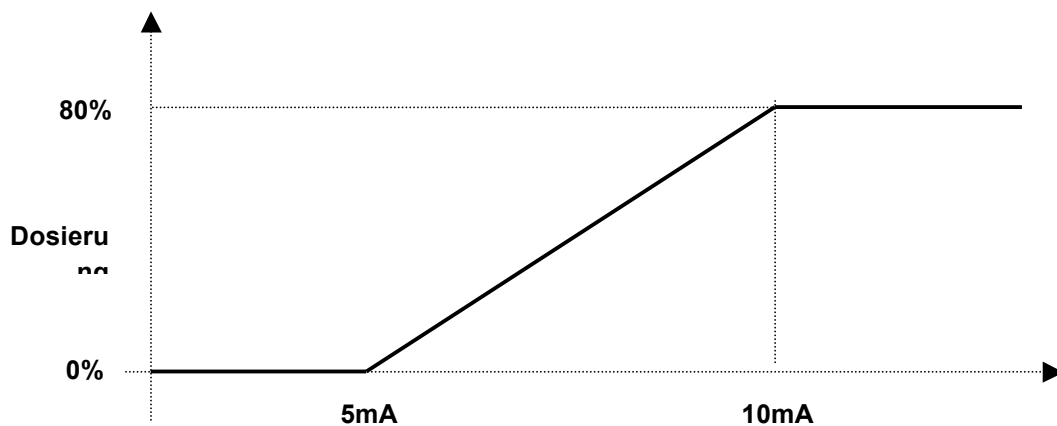

mA Eingang für MAX FÖRDERLEISTUNG = 10mA

Maximale Förderleistung = 80%

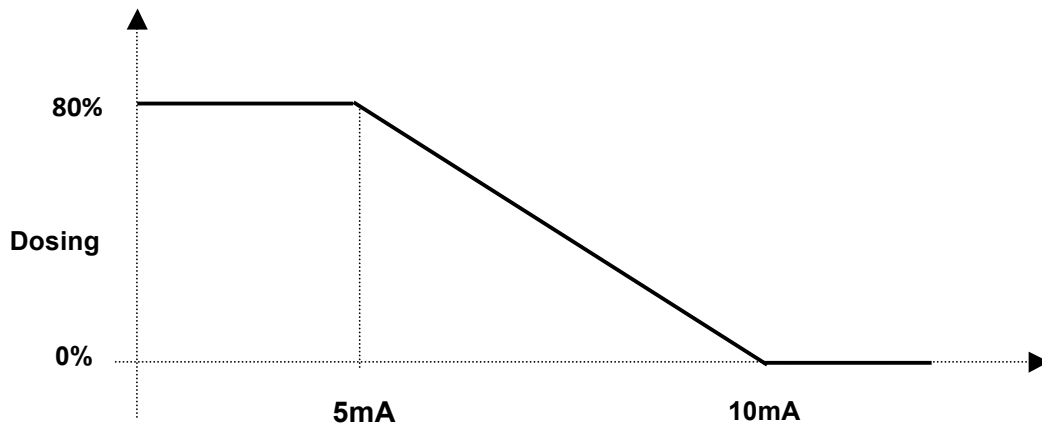

Beispiel: **Umgekehrte** mA Dosierung:
 mA Eingang 0% = 10mA
 mA Eingang für MAX FÖRDERLEISTUNG = 5mA
 Maximale Förderleistung = 80%





Programmierung	Vorgang
<div style="text-align: center;"> <div style="border: 1px solid black; background-color: #d9ead3; padding: 5px; width: fit-content; margin: 0 auto;">mA MODUS MAX DOS @ 20.0mA</div> <div style="text-align: center; margin: 5px 0;">↓</div> <div style="border: 1px solid black; background-color: #d9ead3; padding: 5px; width: fit-content; margin: 0 auto;">mA MODUS 0% DOS @ 04.0mA</div> </div>	<p>In diesem Modus dosiert die Pumpe proportional zu einem Signal von 0/4-20 mA. Ausgehend von der werksseitigen Einstellung bricht die Pumpe die Dosierung bei 0mA ab und dosiert bei maximaler Förderleistung bei Empfang von 20 mA. Diese beiden Werte können bei der Programmierung bearbeitet werden. Die Höchst- und Mindestfrequenz kann während des Betriebs durch Drücken der Tasten  gesteigert, bzw. durch Drücken der Tasten   verringert werden.</p>

Bei PPM Modus:

Um die ausgewählte PPM der Chemikalie beizubehalten, berechnet die Pumpe die korrekte Dosierung ausgehend von folgenden Parametern:

- Impuls pro Minute oder Impulseingang
- Durchflussmesser Faktor (Impuls/Liter)
- Dichte der Chemikalie
- Konzentration der Chemikalie

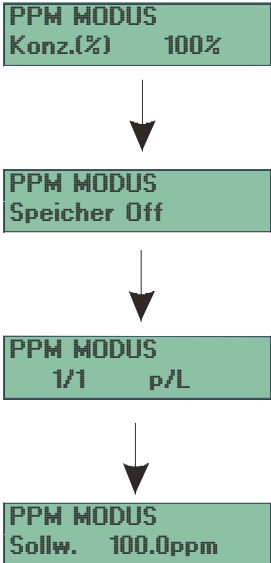
Ist die berechnete Fördermenge größer als der Höchstwert, schaltet die Pumpe auf SPEICHER Funktion (falls gewählt) und dosiert die bleibende Menge, falls möglich.

Programmierung	Vorgang
 <pre> graph TD A[PPM MODUS Konz.(%) 100%] --> B[PPM MODUS Speicher Off] B --> C[PPM MODUS 1/1 p/L] C --> D[PPM MODUS Sollw. 100.0ppm] </pre>	<p>In diesem Modus dosiert die Pumpe proportional zu einem externen Signal (d.h. Impulsgeberzähler), wobei das Verhältnis den Eingangssignalen und der Pumpengeschwindigkeit, abhängig von programmierten Sollwert automatisch berechnet wird.</p> <p>Die Fördermenge bzw. Dosierfrequenz kann während des Betriebs durch Drücken der Tasten  gesteigert, bzw. durch Drücken der Tasten  verringert werden.</p> <p>Mögliche Einstellungen:</p> <ul style="list-style-type: none"> • Konz.(%)= Produktkonzentration. • Speicher= Die Pumpe hat eine Speicherfunktion, welche bei der Dosierung einen Signalempfang anzeigt. Bei Einstellung auf AUS wird kaum ein Signal abgegeben, bei Einstellung auf AN wird ein Signal gesendet, die Impulse werden gespeichert und nach vollständigem Signalempfang ausgeführt. • 1/1= Anzahl der Impulse pro Liter (1/1-999/999), folglich erfolgt die Dosierung nach den eingestellten Werten. • Sollw.= PPM Wert, den das System dosiert.

Bei 1:N Modus:

Die Pumpendosierung erfolgt nach Anzahl der Impulse am entsprechenden Eingang.
 Ein Eingangsimpuls bewirkt 1 Sekunde Dosierung bei eingestellter Geschwindigkeit (N)
 z.B.:

- Falls N gleich 1 (N=1), dosiert die Pumpe 1 Sekunde lang bei 1% der Höchstgeschwindigkeit
- Falls N gleich 100 (N=100), dosiert die Pumpe 1 Sekunde lang bei 100% (Höchstgeschwindigkeit)

Version	Durchschnitt. Dosierung @ 1%*	Durchschnitt. Dosierung @ 100%*
10000ml/h	0.027ml	2.77ml
2000ml/h	0.0055ml	0.55ml

* pro Sekunde dosierte Menge

Ist die berechnete Fördermenge größer als der Höchstwert, schaltet die Pumpe auf SPEICHER Funktion (falls gewählt) und dosiert die bleibende Menge, falls möglich.

Programmierung	Vorgang
<div style="text-align: center;"> <div style="border: 1px solid black; background-color: #d9ead3; padding: 5px; width: fit-content; margin: 0 auto;">1:N MODUS Speicher Off</div> <div style="text-align: center; margin: 10px 0;">↓</div> <div style="border: 1px solid black; background-color: #d9ead3; padding: 5px; width: fit-content; margin: 0 auto;">1:N MODUS 1:1</div> </div>	<p>In diesem Modus dosiert die Pumpe proportional zu einem externen Signal (d.h. Impulsgeberzähler). Pro Eingangssignal dosiert die Pumpe 1 Sekunde lang bei der programmierten Geschwindigkeit N, z.B. 20%. Der Wert „N“ kann während des Betriebs durch Drücken der Tasten gesteigert, bzw. durch Drücken der Tasten verringert werden.</p> <p>Mögliche Einstellungen:</p> <ul style="list-style-type: none"> • Speicher= Die Pumpe hat eine Speicherfunktion, welche bei der Dosierung einen Signalempfang anzeigt. Bei Einstellung auf AUS wird kaum ein Signal abgegeben, bei Einstellung auf AN wird ein Signal gesendet, die Impulse werden gespeichert und nach vollständigem Signalempfang ausgeführt. • 1:N= Pro Eingangssignal dosiert die Pumpe 1 Sekunde lang bei der programmierten Geschwindigkeit N, z.B. 20%.

Bei N:1 Modus:

Die Pumpendosierung erfolgt nach Anzahl der Impulse am entsprechenden Eingang.
N Eingangsimpuls bewirken 1 Sekunde Dosierung bei 1%
z.B.:

- Falls N gleich 1 (N=1), dosiert die Pumpe 1 Sekunde lang bei 1% der Höchstgeschwindigkeit
- Falls N gleich 100 (N=100), wartet die Pumpe auf 100 Impulse für eine Sekunde bei 1% der Höchstgeschwindigkeit

Version	Durchschnitt. Dosierung @ 1%*	Durchschnitt. Dosierung @ 100%*
10000ml/h	0.027ml	2.77ml
2000ml/h	0.0055ml	0.55ml

* pro Sekunde dosierte Menge







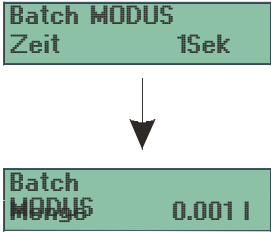

Ist die berechnete Fördermenge größer als der Höchstwert, schaltet die Pumpe auf SPEICHER Funktion (falls gewählt) und dosiert die bleibende Menge, falls möglich.

Programmierung	Vorgang
<div style="text-align: center;"> <div style="border: 1px solid black; background-color: #d9ead3; padding: 5px; width: fit-content; margin: 0 auto;">N:1 MODUS Speicher Off</div> <div style="text-align: center; margin: 10px 0;">↓</div> <div style="border: 1px solid black; background-color: #d9ead3; padding: 5px; width: fit-content; margin: 0 auto;">N:1 MODUS 1:1</div> </div>	<p>In diesem Modus dosiert die Pumpe proportional zu einem externen Signal (d.h. Impulsgeberzähler). Pro programmierte "N" Eingangssignale dosiert die Pumpe 1 Sekunde lang bei 1% der Höchstgeschwindigkeit. Der Wert „N“ kann während des Betriebs durch Drücken der Tasten gesteigert, bzw. durch Drücken der Tasten verringert werden.</p> <p>Mögliche Einstellungen:</p> <ul style="list-style-type: none"> • Speicher= Die Pumpe hat eine Speicherfunktion, welche bei der Dosierung einen Signalempfang anzeigt. Bei Einstellung auf AUS wird kaum ein Signal abgegeben, bei Einstellung auf AN wird ein Signal gesendet, die Impulse werden gespeichert und nach vollständigem Signalempfang ausgeführt. • N:1= Pro programmierte "N" Eingangssignale dosiert die Pumpe 1 Sekunde lang bei 1% der Höchstgeschwindigkeit.

Bei Batch Modus:

Die Pumpe dosiert die eingestellte Menge, wenn die UP Taste gedrückt wird oder ein Eingangsimpuls empfangen wird (andere Impulse werden während der Dosierung nicht beachtet) oder falls Triggersignale ausgewählt werden und gültige Trigger-Eingangssignale gelesen werden.

Ist die eingestellte Dosierungszeit zu kurz, erfolgt die Dosierung bei der maximalen Fördermenge.

Programmierung	Vorgang
	<p>In diesem Modus dosiert die Pumpe proportional zu einem externen Signal (d.h. Impulsgeberzähler). In diesem Fall kann die Dosiermenge und die Zeit bis zum Ausführend der Dosierung eingestellt werden.</p> <p>Die Dosierung kann manuell mit der Taste  oder mit der Fernbedienung gestartet werden. Mit der Taste  wird die Dosierung abgebrochen. Die bereits eingestellte Dosierung kann manuell mit der Taste  resettet oder mit der Taste  neu gestartet werden.</p> <p>Die Dosiermenge kann während des Betriebs durch Drücken der Tasten   gesteigert, bzw. durch Drücken der Tasten   verringert werden.</p> <p>Mögliche Einstellungen:</p> <ul style="list-style-type: none"> • Zeit= Zeit zum Ausführend der Dosierung in Sekunden • Menge = Dosiermenge in Litern.

Paragraph 6

Folgende Pumpenfunktionen können eingestellt werden:

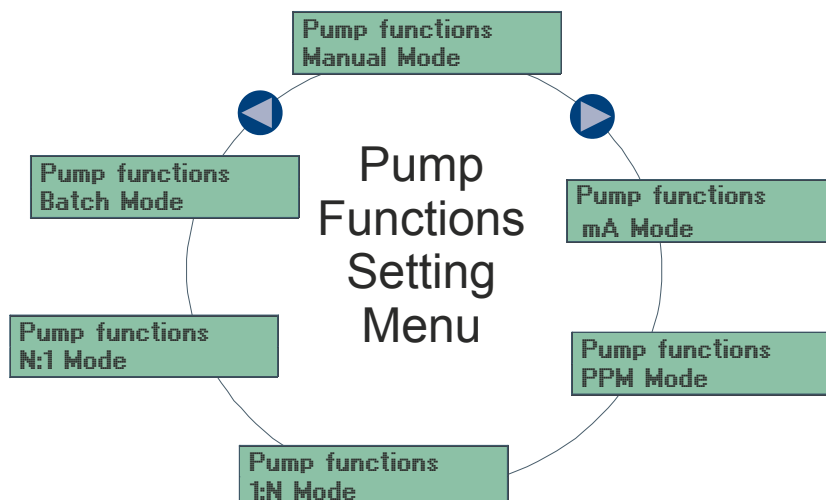

Paragraph 7

Programmierung	Vorgang
Dichte 1.00 kg/l	Möglichkeit zur Einstellung der Dichte der Chemikalie.

Paragraph 8

Programmierung	Vorgang
Trigges Keine Trg	<p>Möglichkeit zur Einstellung der Eingangs-Trigger. Sind die Trigger vorhanden, erfolgt der Konsens zum Pumpenbetrieb je nach Einstellung der Funktion:</p> <ul style="list-style-type: none"> • Keine Trg= Trigger deaktiviert. • Trg 1= Pumpe läuft, wenn nur Trigger 1 freigeschaltet ist. • Trg 2= Pumpe läuft, wenn nur Trigger 2 freigeschaltet ist. • Trg 1&2= Pumpe läuft wenn beide Trigger (1 u. 2) freigeschaltet sind.

Paragraph 9

Programmierung	Vorgang
Einheiten l/h	<p>Möglichkeit zur Einstellung der Maßeinheit:</p> <ul style="list-style-type: none"> • L/h= Liter pro Stunde. • ml/m= Milliliter pro Minute. • Gph= Gallon pro Stunde. • %= Prozentwert der maximalen Fördermenge.

Paragraph 10

Programmierung	Vorgang
Summer Off	<p>Im Alarmzustand ist der Summer aktiv. Möglichkeit zur Einstellung des Summers auf ON oder OFF.</p>

Paragraph 11

Programmierung	Vorgang
Füllstand Alarm Stopp	<p>Möglichkeit zur Einstellung des Füllstand-Alarms:</p> <ul style="list-style-type: none"> • Stopp= Pumpe stoppt. • Betrieb= Der Pumpenbetrieb läuft weiter.

Paragraph 12



Programmierung	Vorgang
<div style="border: 1px solid black; padding: 5px; width: fit-content; margin: 10px auto;"> Alarm Relais N.Open </div>	Möglichkeit zur Einstellung des Relais-Alarms: <ul style="list-style-type: none"> • N.Open= normally open. • N.Closed= normally closed.

Paragraph 13



Programmierung	Vorgang
<div style="border: 1px solid black; padding: 5px; width: fit-content; margin: 10px auto;"> Max Förderleistung 100% 10.000 L </div>	Möglichkeit zur Einstellung der maximalen Förderleistung der Pumpe. Die Programmeinstellung (% oder Frequenz) wird bei der Anzeige der Fördermenge als Standardmaß verwendet.

9. Wartung



9.1 Schlauch Auswechseln

Steht die Pumpe auf **Stopp** (Taste  drücken) und wird die Taste  mindestens 3 Sekunden lang gedrückt, läuft die Pumpe bei Mindestdrehzahl gegen den Uhrzeigersinn, um das Entfernen des Schlauchs zu erleichtern.

Abbruch des Pumpenbetriebs durch Drücken von Taste .

Wird die Taste  beim gleichen Vorgang mindestens 3 Sekunden lang gedrückt, läuft die Pumpe bei Mindestdrehzahl, um das Austauschen des Schlauchs zu erleichtern. Abbruch des Pumpenbetriebs durch Drücken von Taste .

9.2 LCD Farbkontrast

Steht die Pumpe auf **Stopp** (Taste  drücken), wird der Farbkontrast mit den Tasten  und  verringert bzw. erhöht.

10. Displayansicht

10.1 Während der Dosierung

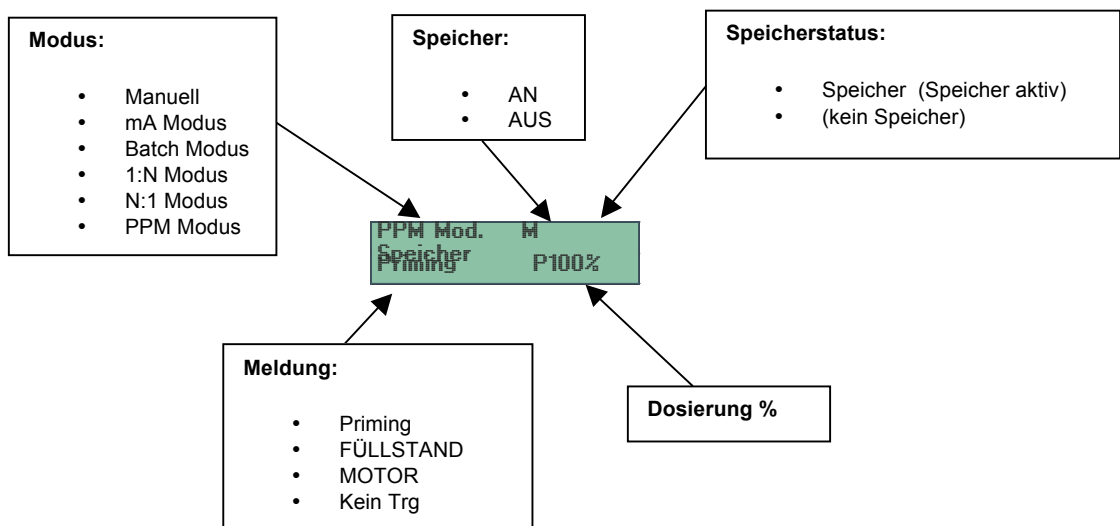

10.2 Während des Pumpenstillstandes

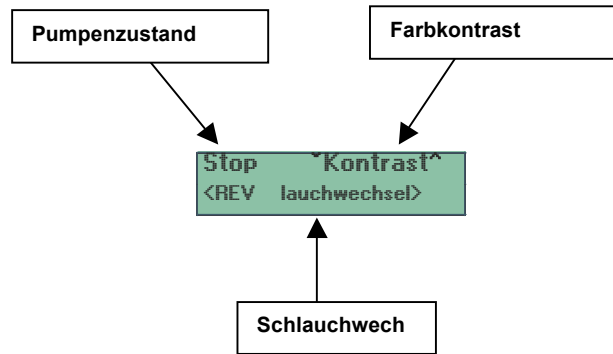

11. SCHNELLE PARAMETEREINSTELLUNG

Von der Dosierungsanzeige aus die Taste  mindestens drei Sekunden lang drücken, und das Display schaltet zur schnellen Parametereinstellung:

```
Manuell
Max % 100%
```

In diesem Menü können folgende Elemente bearbeitet werden:

1) max. Förderleistung

- mA Modus
- Manuell

2) N in:

- 1:N Modus
- N:1 Modus

3) Menge in:

- Batch Modus

4) PPM in

- PPM Modus

Zur Bearbeitung des Istwerts die Tasten  und  oder  gedrückt halten.

12. Übersicht der Parameter

	Parameter	Wert	Wert	Wert	Wert	Wert	Wert	Default
1	Sprache	Englisch	Deutsch	Italienisch				Englisch
2	Passwort	0 - 9999						0 (deaktiviert)
3	Statistik	Dosierzeit (h)	Schlauchzeit (h)	Liter				
4	Max. Förderleistung	0.1 – 100.0%						100.0%
5	Pumpenbetrieb	Manuell	mA Modus	Batch Modus	1 :N Modus	N:1 Modus	PPM Modus	Manuell
6	Alarm Relais	NO	NC					NO
7	Füllstand Alarm	Stopp	Betrieb					Stopp
8	Summer	AN	AUS					AUS
9	Einheit	ml/h	L/h	%				ml/h
10	Trigger	Kein Trg	Trg 1	Trg 2	Trg 1&2			Kein Trg
11	Dichte	0.50-2.00						1.00
12	AN Zeit	0-10000						10
13	AUS Zeit	0-10000						0
14	Verzögerung	0-10000						0
15	mA für 0%	0.0-20.0						4.0
16	mA für max	0.0-20.0						20.0
17	N	1-1000						1
18	Impuls	1-2000						1
19	Liter	1-2000						1
20	Chem. Konz.	1-100						100
21	ppm	0-10000						1000
22	Speicher	AN	AUS					AUS
23	Menge	0-30000						1
24	Zeit	0-10000						1
25	Förderleistung	Kalibr.						10000

13. Übersicht der Dosierparameter

Modus	Param 1	Param 2	Param 3	Speicher	Trigger	Max. Förderleistung	Dichte
Manuell	AN Zeit Sek (<u>0</u> -10000)	AUS Zeit Sek (<u>0</u> -10000)	VERZÖGERUNG Sek (<u>0</u> -10000)		Trigger Kein Trg/Trg 1/Trg 2/Trg 1&2)	MAX. FÖRDERLEISTUNG (0.1 – <u>100</u> %)	
Direkte oder umgekehrte mA	mA Eingang für Minstdosierung (<u>0.0</u> -20.0 mA)	mA Eingang für max. Dosierung (0.0- <u>20.0</u> mA)			Trigger Kein Trg/Trg 1/Trg 2/Trg 1&2)	MAX. FÖRDERLEISTUNG (0.1 – <u>100</u> %)	
ppm	Sollwert (<u>1</u> -3000 ppm)	Durchflussmesser Faktor (<u>1</u> -2000 Imp / 1-2000 l)	Chem. Konz. (<u>1</u> - <u>100</u> %)	Speicher (ON- OFF)	Trigger Kein Trg/Trg 1/Trg 2/Trg 1&2)		Dichte (0.50 – 2.00 kg/L) <u>1.00</u>
Batch	Menge (<u>1</u> -30000ml)	Zeit Sek.: (<u>1</u> -10000)		Speicher (ON- OFF)			Dichte (0.50 – 2.00 kg/L) <u>1.00</u>
PROP 1:N	N (<u>1</u> -1000)			Speicher (ON- OFF)	Trigger Kein Trg/Trg 1/Trg 2/Trg 1&2)		
PROP N:1	N (<u>1</u> -1000)			Speicher (ON- OFF)	Trigger Kein Trg/Trg 1/Trg 2/Trg 1&2)		

Default Parameter sind unterstrichen und fettgedruckt

14. Übersicht der Alarmanzeigen

Alarm	Dosierung	Display	Summer	Relais
Schlauchbruch	Stopp	SCHLAUCHBRUCH	AN falls gewählt	AN falls gewählt
FÜLLSTAND	Stopp falls gewählt	FÜLLSTAND	AN falls gewählt	AN falls gewählt
MOTOR	Stopp	MOTOR	AN falls gewählt	AN falls gewählt

1. INFORMACIÓN DE SEGURIDAD

Explicación de la información de seguridad.



Atención – alta- tensión



Atención – superficie caliente



Atención - zona peligrosa

Uso apropiado y correcto

- La bomba debe usarse para medir químicos alimentados en forma de líquidos.
- Este sistema puede usarse sólo de conformidad con los datos técnicos y las especificaciones enunciadas en el Manual de funcionamiento.
- La bomba sólo debe ser usada si ha sido instalada correctamente y asignada al uso.
- Se prohíbe todo otro uso y modificación.
- La bomba no ha sido diseñada para medir medios gaseosos o sólidos.
- La bomba no puede usarse al aire libre sin una protección adicional (cobertura, techo de protección meteorológica).
- La bomba debe ser operada únicamente por personal autorizado y capacitado, ver la tabla siguiente.
- Es obligatoria la observancia de la información contenida en las instrucciones de funcionamiento en las diferentes fases de la vida útil del sistema.

Personal técnico

Un empleado calificado es aquel capaz de llevar a cabo las tareas que le han sido asignadas y reconocer posibles riesgos basados en su capacitación, conocimientos y experiencia, como también el conocimiento de las regulaciones en materia.

Electricista

El electricista es aquel que es capaz de completar el trabajo en los sistemas eléctricos y reconocer y evitar posibles peligros basados independientemente de su capacitación técnica y experiencia, como también el conocimiento de las normas y regulaciones relativas. El electricista debe estar capacitado específicamente para trabajar en un ambiente donde se emplean sistemas eléctricos y conocer las normas y estándares respectivos. Los electricistas deben observar las disposiciones de las directivas estatutarias aplicables relativas a la prevención de accidentes .

Personal instruido

Una persona instruida es aquella que ha sido capacitada y, si se lo requiere, entrenada en las tareas asignadas y posibles daños que pudieran derivar de un comportamiento inapropiado, como también haber sido instruido en el equipo de protección requerido y en las medidas de protección.

Equipo de protección

La cubierta transparente cubre el líquido y sirve para prevenir que las personas toquen el rotor en movimiento y previene la medición de pérdidas promedio en el caso de rotura de la manguera.

Información en caso de una emergencia

Extraer los enchufes de conexión a la red o presionar uno de los botones de parada de emergencia, en el caso de una emergencia.

En caso de fugas de químicos, despresurizar el sistema hidráulico alrededor de la bomba. Observar la hoja de datos de seguridad para el químico base.

2. SOBRE EL PRODUCTO

El producto **Kronos** es una bomba peristáltica de medición accionada por un motor a pasos. El químico es transportado por medio de un rotor vaciando en la manguera. No se requieren válvulas para ellos. Esto garantiza una manipulación suave del medio de medición.

Sus aplicaciones típicas son en procesos donde se requiere sólo una presión de descarga baja, como en la medición de químicos en baños galvánicos, en depósitos de clarificación o para la medición de agentes acondicionadores en piscinas de natación (floculantes, carbón activo y químicos).

El cárter está construido con material resistente a los golpes y resistente a químicos PPE con grado de protección IP65.

Está equipado con varias entradas para la configuración de la medición. El motor a pasos significa que la medición es ajustable infinitamente.

A continuación se incluye una descripción general de las características más importantes:

- Alimentación 100÷240 Vac 50/60 Hz
- Intervalo de salida: 0.010 ÷ 10.00 l/h @ 2bar o 0.002 ÷ 02.00 l/h @ 3bar
 - 0.010 ÷ 10.00 l/h @ 2bar or 0.002 ÷ 02.00 l/h @ 3bar
 - Material de la manguera SekoExtra or SekoMed (otro a pedido)
 - 0.008 ÷ 8.00 l/h @ 3bar o 0.003 ÷ 03.00 l/h @ 6bar
 - Material de la manguera SekoTech
- Potente motor a pasos, velocidad configurable
- Ajuste infinito de la salida de medición manual o externamente mediante señales 0/4-20 mA
- Función cebado (ejecución en alta velocidad)
- Visualización de salida de medición en la pantalla en l/h, ml/m, Gph o %
- Dirección reversible
- Clase de protección del cárter IP 65
- Sistema de frenado tubo
- Fusible 1,6A (20W)

3. DIMENSIONES Y GENERALIDADES DISPOSITIVO

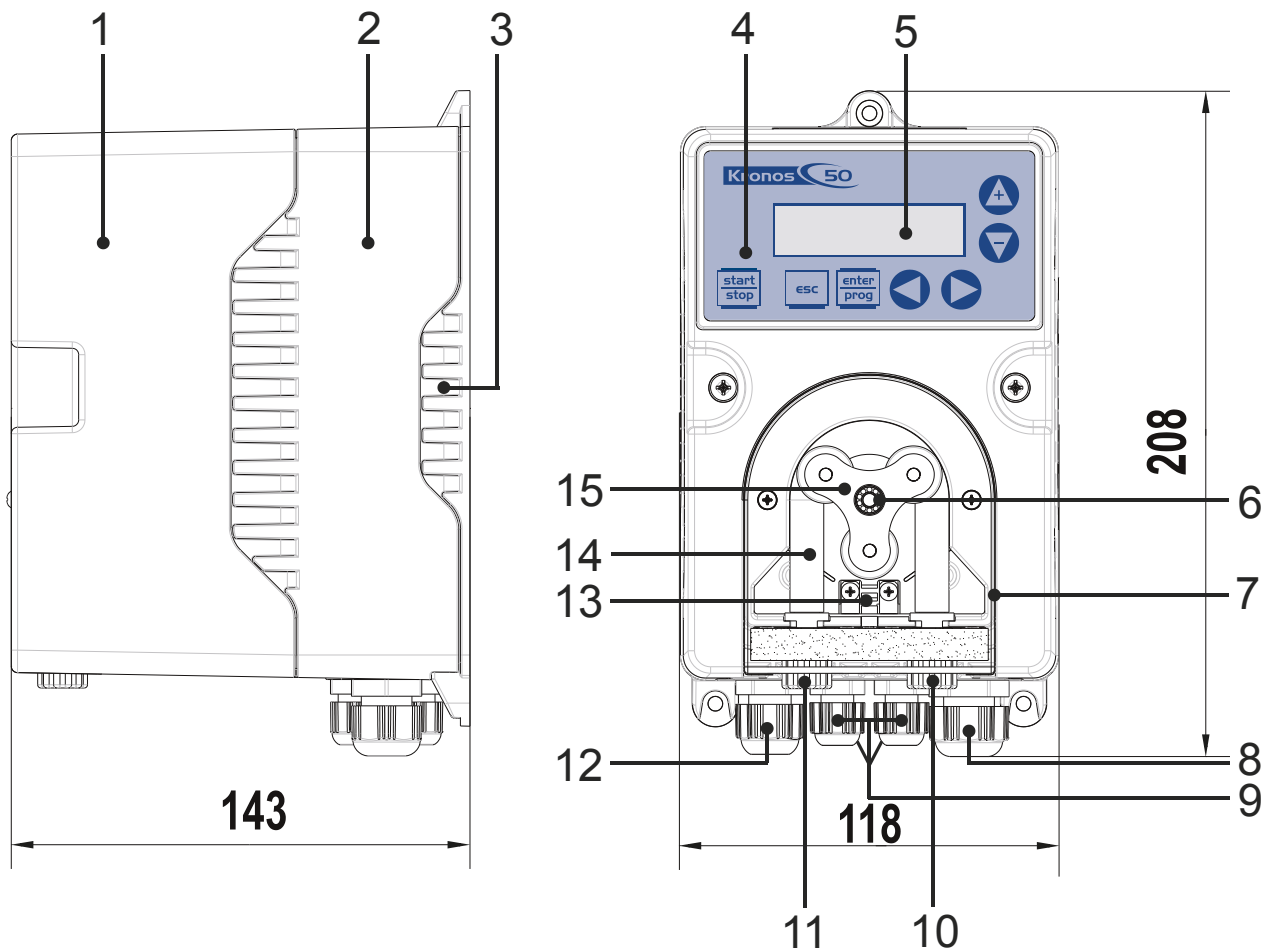

1	Cárter: sección superior	9	PCBs 7
2	Cárter: sección central	10	Conector de descarga
3	Cárter: sección inferior	11	Conector de succión
4	Claves de control	12	PCB 9
5	Display LCD	13	Supervisión rotura manguera
6	Rodamiento de bolas	14	Manguera bomba
7	Tapa transparente	15	Rotor
8	PCB 11		

4. DESCRIPCIÓN FUNCIONAL Y DISEÑO

La bomba dispone de dos componentes:

- Unidad de transmisión (motor a pasos)
- Extremo líquido (rotor, rodillos y manguera bomba)

Unidad de funcionamiento

El dispositivo está alojado en un alojamiento plástico resistente. El alojamiento plástico dispone de una sección superior y otra inferior, que están atornilladas juntas. La sección inferior contiene el PCBs para el suministro de energía y los conectores. La sección superior del alojamiento contiene el CPU, el motor y el display PCB con monitor y botones.

El extremo líquido está montado en la parte frontal y está cerrado mediante una tapa transparente empernada como protección contra las lesiones. La manguera de la bomba puede intercambiarse fácilmente después de haber quitado la tapa transparente.

El movimiento rotatorio de los rodets, presionan y aflojan alternativamente la manguera de la bomba mediante tres rodillos. Como resultado, el líquido es succionado hacia el interior y transportado a través de la manguera de presión.

La bomba es operada por una unidad de funcionamiento. Con ésta se configuran el nivel deseado de medición y el modo. La operación de medición es controlada con la unidad operativa o mediante un contacto externo, entrada de nivel.

5. INSTALACIÓN

1. Marcar los orificios en la pared
2. Perforar los orificios de \varnothing 8 mm e insertar los tarugos suministrados
3. Fijar la abrazadera en la pared
4. Enganchar el dispositivo en la parte superior

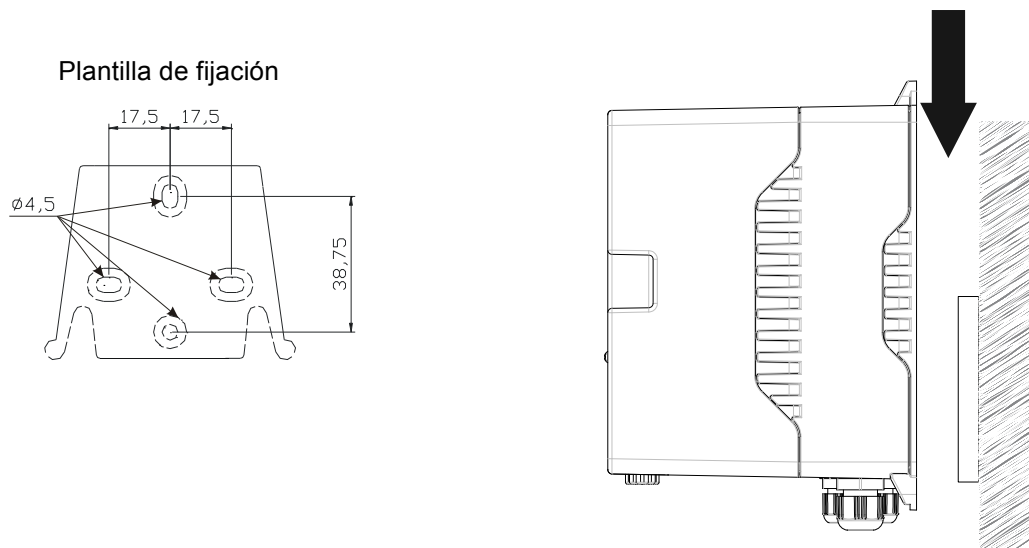

6. INSTALACIÓN HIDRÁULICA

Montar las líneas de descarga y succión:

1. Cortar los extremos de las mangueras para que estén derechos.
2. Atornillar en el sombrerete y deslizar sobre la manguera.
3. Atornillar en el extremo de la manguera hasta que se pare sobre la boquilla.
4. Conectar la línea de descarga en la conexión del lado derecho de la manguera.
5. Conectar la línea de succión en la conexión del lado izquierdo de la manguera.
6. Apretar los sombreretes.
7. Para ello, acortar el extremo libre de la línea de succión que sujeta el extremo apenas encima del fondo del contenedor.
8. Si fuera necesario, alimentar una manguera desde la fijación con pérdida hacia el container.

7. INSTALACIÓN ELÉCTRICA

1. Colocar un cable de alimentación con una protección contra cortocircuitos y un disyuntor, si fuera necesario, con un \square interruptor de parada de emergencia.
2. ¡Asegurarse de que el cable de alimentación esté sin tensión!
3. Romper el pequeño orificio en la parte derecha del lado inferior de la sección posterior mediante un destornillador.
4. Enroscar el tornillo y apretarlo, no el tornillo de la superficie.
5. Insertar los insertos de reducción según el diámetro de cable usado e introducir el conjunto roscado.
6. Alimentar los cables dentro del conjunto roscado.
7. Conectar el cable de alimentación al bloque terminal.
8. Apretar el tornillo de fijación para que el conjunto roscado sea resistente a la humedad.

6.1 Conexiones eléctricas

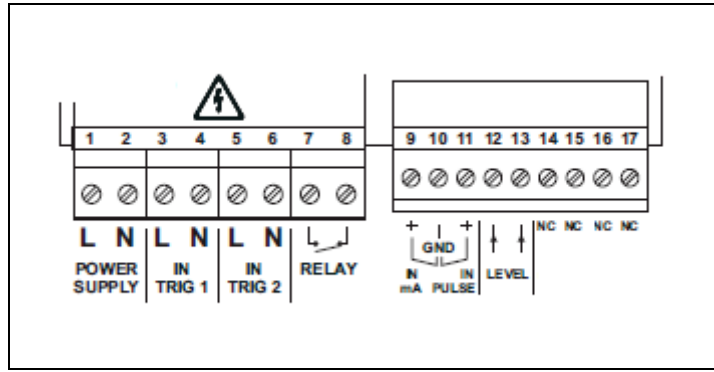

Número de terminales	Descripción	Características eléctricas	
1 - 2	Fuente de alimentación	100÷240 VAC (50–60Hz)	
3 - 4	Disparador 1 señal de entrada	24÷240 VAC o VDC	
5 - 6	Disparador 2 señal de entrada	24÷240 VAC o VDC	
7 - 8	Alarma salida relé	250VAC 8A	
9 - 10	9 Polo + (mA)	Entrada mA	0/4÷20 mA (Entrada impedancia: 200 ohm)
	10 Polo - (GND)		
10 - 11	10 Polo - (GND)	Impulsos entrada	Impulsos libres desde la tensión (medidor emisión impulsos; contacto seco: on-off, frecuencia máxima 1 KHz)
	11 Polo + (Impulso)		
12 - 13	Entrada sonda control nivel	Contacto seco (on-off)	
14 -15 -16 -17	no utilizado.	no utilizado.	

8. UNIDAD DE FUNCIONAMIENTO

8.1 Claves de control





Los claves de control son las siguientes:

Clave	Descripción
	Arranca y detiene la bomba. En caso de alarma de nivel (sólo función alarma), alarma flujo y alarma memoria activa, desactiva la señal en la pantalla.
	Usado para "salir" de los diferentes niveles de menú. Antes de salir definitivamente de la fase de programación, se le preguntará si desea guardar los cambios.
	Cuando se lo presiona durante la fase de funcionamiento de la bomba, visualiza cíclicamente los valores programados en la pantalla. Cuando se lo presiona contemporáneamente o las teclas, aumenta o disminuye el valor dependiendo del modo de funcionamiento seleccionado. Durante la programación realiza la función "enter", es decir, confirma la entrada a los diferentes niveles de menú y las modificaciones.
	Utilizado para ejecutar hacia arriba a través del menú
	Utilizado para ejecutar hacia abajo el menú o para el cebado, manteniéndolo allí durante 3 segundos como mínimo, la bomba iniciará a funcionar al 100% hasta que se presione la tecla.
	Utilizado para aumentar los valores numéricos a cambiar. Puede usarse para iniciar la dosificación en modo Batch.
	Utilizado para disminuir los valores numéricos a cambiar.

8.2 Menú programación

Puede acceder al menú programación presionando la tecla .

Las teclas   pueden usarse para ejecutar a través de los ítems de menú, con la tecla  usada para acceder a los cambios.



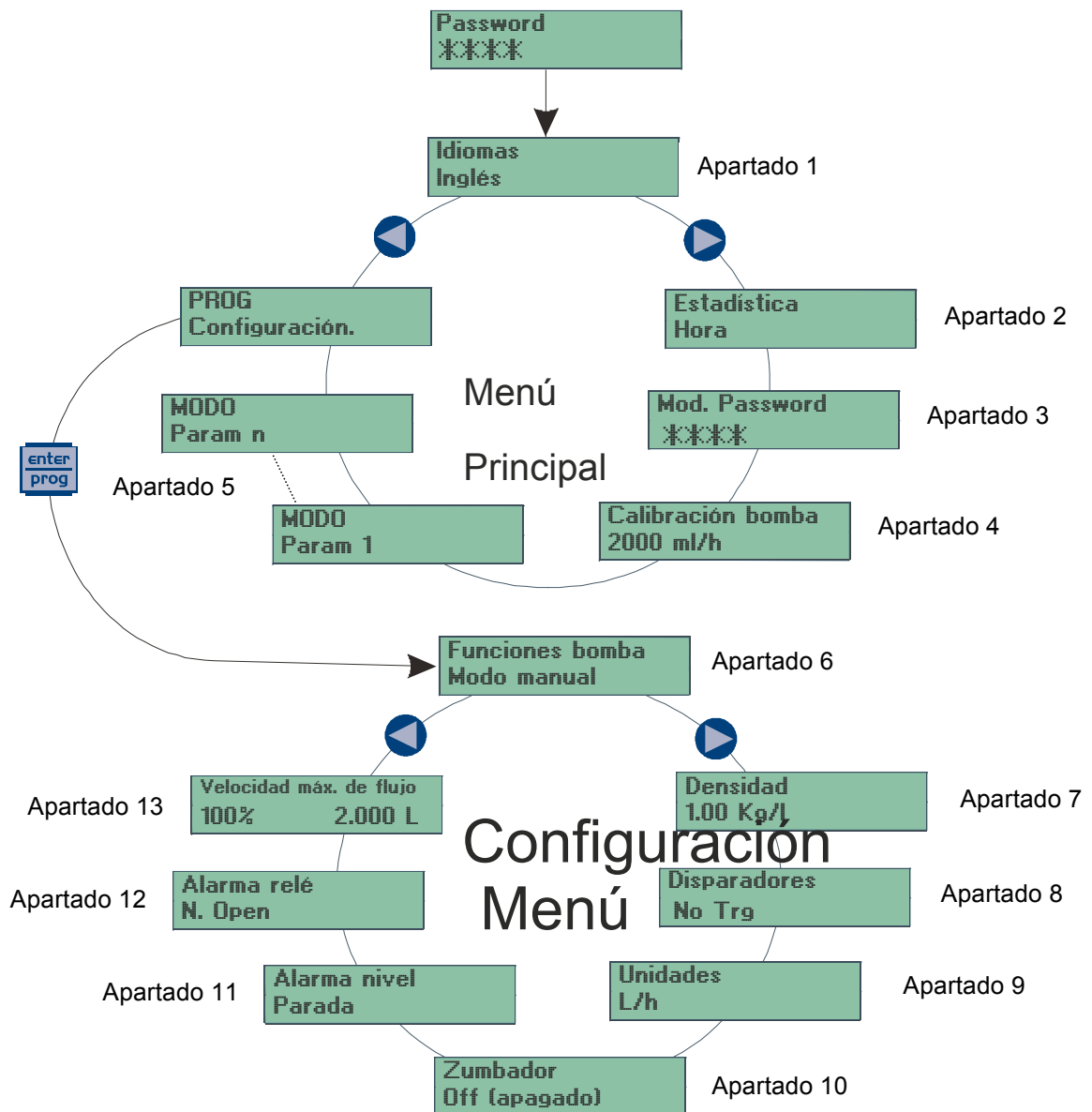

La bomba está programada de fábrica en modo constante. La bomba retorna automáticamente al modo de funcionamiento después de 1 minuto de inactividad. No se guardarán los datos ingresados bajo estas circunstancias.

La tecla  puede usarse para salir de los diferentes niveles de programación. Con la programación existente, la pantalla mostrará:







     para confirmar la selección.







Apartado 1

Programación	Funcionamiento
	<p>Permite seleccionar un idioma. La bomba está programada de fábrica en inglés.</p> <p>Los cambios pueden realizarse presionando la tecla ,</p> <p>usando las teclas   para configurar el nuevo valor.</p> <p>Presionar  para confirmar y volver al menú principal.</p>



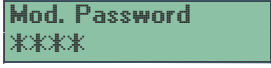

Apartado 2

Programación	Funcionamiento
	<p>El menú principal visualiza los tiempos de operación de la bomba.</p> <p>Presionando la tecla  se puede acceder a otras estadísticas:</p> <ul style="list-style-type: none">- Horas tuberías = tiempo funcionamiento tuberías.- Cant. (litros) = cantidad dosificada en litros por la bomba.- Resetear = usar el botón   para resetear los contadores (SÍ) o (NO), después confirmar presionando la tecla . <p>Presionando la tecla  se volverá al menú principal.</p>

Apartado 3

Programación	Funcionamiento
	<p>Permite cambiar el acceso contraseña.</p> <p>Los cambios pueden realizarse presionando la tecla ,</p> <p>usando las teclas   para configurar el nuevo valor.</p> <p>Para deshabilitar la contraseña, ingresar el valor 0000.</p> <p>Presionando la tecla  se volverá al menú principal.</p>

Apartado 4

Programación	Funcionamiento
<div style="border: 1px solid black; padding: 5px; width: fit-content; margin: 0 auto;">Calibrado 2000 ml/h</div>	<p>La bomba puede calibrarse del modo siguiente:</p> <p>la bomba funciona a una velocidad máxima durante 36 seg (versión 10 l/h) o 180 seg (versión 2 l/h) , que arranca presionando la tecla .</p> <p>Al final del tiempo, ingresar la cantidad succionada por la bomba usando las teclas   y confirmar presionando la tecla .</p> <p>El valor ingresado se usará para el cálculo del flujo.</p>

Apartado 5

Estos ítems de menú son diferentes según las configuraciones de menú:



- **Modo manual**
- **Modo mA**
- **Modo Ppm**
- **1 : Modo N**
- **N : Modo 1**
- **Modo en lote**



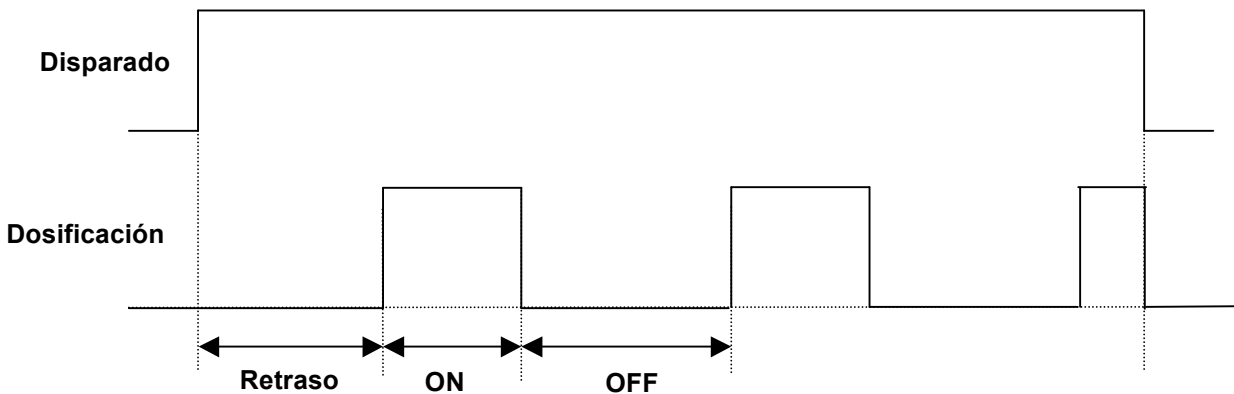

Caso **Modo manual**:

La bomba dosifica a una velocidad de flujo seleccionada. Si el tiempo OFF está configurado en 0 seg, la bomba funciona continuamente.
 La bomba inicia a dosificar después de un tiempo de retardo seleccionable.

Ex. Dosificación manual con disparador:

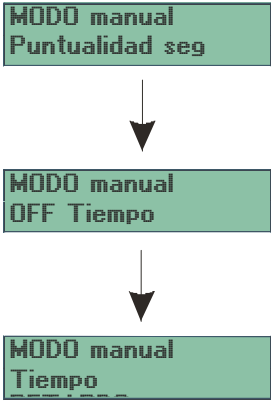

Si no se selecciona un disparador, el retardo de arranque de la bomba inicia a contarse después de su encendido.

Programación	Funcionamiento
 <pre> graph TD A[MODO manual Puntualidad seg] --> B[MODO manual OFF Tiempo] B --> C[MODO manual Tiempo] </pre>	<p>La bomba funciona en modo constante. El flujo puede regularse sólo manualmente presionando las teclas   contemporáneamente para aumentar el flujo, o las teclas   para disminuirlo.</p> <p>Permite configurar:</p> <ul style="list-style-type: none"> • ON Time= Tiempo durante el cual funciona la bomba. • OFF Time= Tiempo durante el cual se para la bomba. • Tiempo RETARDO = tiempo de retardo después del cual la bomba inicia funcionar.

Caso Modo mA:



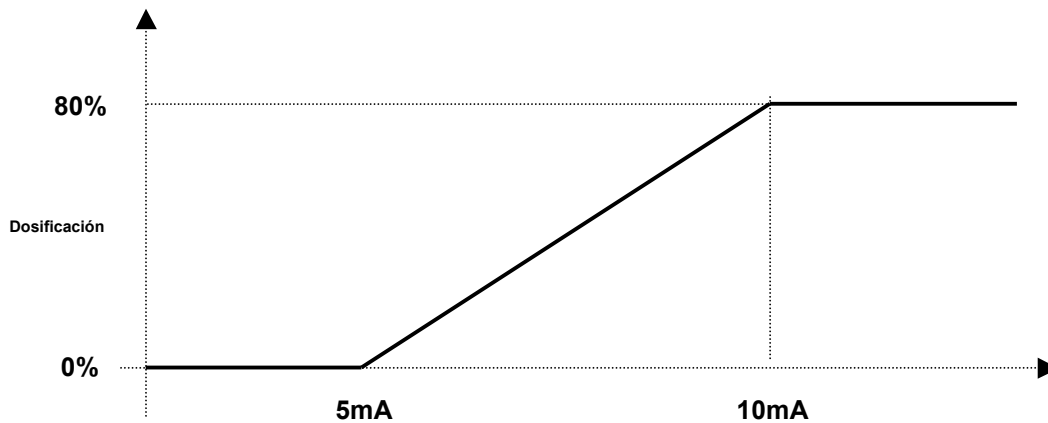

La bomba dosifica proporcionalmente a una señal de (0)4-20 mA o 20-4(0) mA. Se puede configurar el valor de entrada mA correspondiente a 0% de dosificación y el valor de entrada mA correspondiente a la velocidad máxima de flujo de la bomba.

Ex. **Dosificación** mA directa:
 entrada mA para 0% = 5mA
 entrada mA para VELOCIDAD MÁX. FLUJO = 10mA
 Velocidad máx. de flujo = 80%

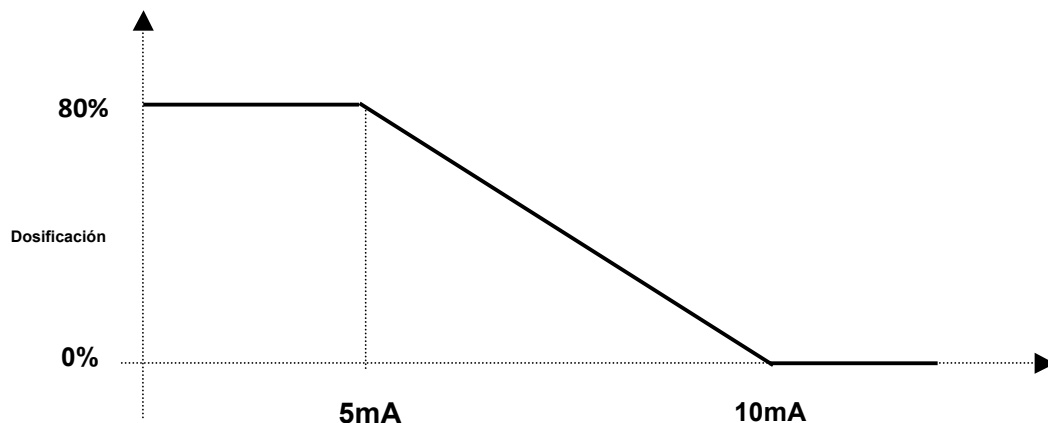

Ex. **Invers** mA dosificación:
 entrada mA para 0% = 10mA
 A entrada mA para VELOCIDAD MÁX. FLUJO = 5mA
 Velocidad máx. de flujo = 80%







Programación	Funcionamiento
	<p>La bomba dosifica proporcionalmente a una señal de 0/4-20 mA. Según las configuraciones de fábrica, la bomba interrumpe la dosificación a 0mA y dosifica a la frecuencia de configuración máxima cuando recibe 20 mA. Estos dos valores pueden modificarse durante la programación. La frecuencia máxima y mínima puede modificarse durante el funcionamiento, presionando las teclas   contemporáneamente para aumentar el flujo, o las teclas   para disminuirlo.</p>

Caso Modo PPM:

Para mantener el ppm seleccionado de químico, la bomba calcula la correcta velocidad de dosificación iniciando desde los siguientes parámetros:

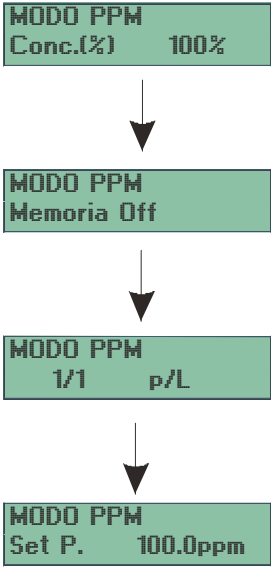
- Impulso por minuto en entrada impulsos
- Factor flujómetro (impulso/litros)
- Densidad de químicos
- Concentración de químicos

Si la velocidad de flujo calculada es mayor al máximo, la bomba se pone en la función MEM (si se lo selecciona) y dosifica la última cantidad, cuando es posible.

Programación	Funcionamiento
 <pre> graph TD A[MODO PPM Conc.(%) 100%] --> B[MODO PPM Memoria Off] B --> C[MODO PPM 1/1 p/L] C --> D[MODO PPM Set P. 100.0ppm] </pre>	<p>La bomba dosifica en proporción a una señal externa (por ej.: mesa de lanzamiento impulso) calculando automáticamente la relación entre las señales entrantes y la velocidad de la bomba según el valor ppm programado.</p> <p>La frecuencia de dosificación puede modificarse durante el funcionamiento, presionando las teclas   contemporáneamente para aumentar el flujo, o las teclas   para disminuirlo.</p> <p>Permite configurar:</p> <ul style="list-style-type: none"> • Conc.(%)= concentración de producto. • Memoria= la bomba tiene una función de memoria, que señala la recepción de una señal durante la dosificación. Si está configurado en Off, envía una señal; si está configurado en On envía una señal y memoriza los impulsos, después los ejecuta cuando ha terminado de recibir las señales. • 1/1= número de impulsos por litros (1/1-999/999) y, de consecuencia, el sistema dosificará según los valores configurados. • Set P.= valor ppm que dosificará el sistema.

Caso1 : Modo N:

La bomba dosifica el número de impulsos siguiente a la entrada relativa.





Un impulso de entrada genera 1 segundo de dosificación a la velocidad configurada (N) por ej.

- Si N está configurado en 1 (N=1) la bomba dosifica durante un segundo a una velocidad = 1% de la velocidad máx.
- Si N está configurado en 100 (N=100) la bomba dosifica durante un segundo a una velocidad = 100% (velocidad máx.)

versión	Dosificación promedio @ 1%*	Dosificación promedio @ 100%*
10000ml/h	0,027ml	2,77ml
2000ml/h	0,0055ml	0,55ml

* cantidad dosificada en 1 segundo

Si la velocidad de flujo calculada es mayor al máximo, la bomba se pone en la función MEM (si se lo selecciona) y dosifica la última cantidad, cuando es posible.

Programación	Funcionamiento
<div style="text-align: center;"> <div style="border: 1px solid black; background-color: #d9ead3; padding: 5px; width: fit-content; margin: 0 auto;">1 :N Modo Memoria Off</div> <div style="text-align: center; margin: 10px 0;">↓</div> <div style="border: 1px solid black; background-color: #d9ead3; padding: 5px; width: fit-content; margin: 0 auto;">1 :N Modo 1:1</div> </div>	<p>La bomba dosifica en proporción a una señal externa (por ej, mesa de lanzamiento impulsos). Con cada señal recibida, la bomba realiza 1 segundo en la "N" programada (por ej: 20%) de velocidad.</p> <p>El valor "N" puede modificarse durante el funcionamiento, presionando las teclas   contemporáneamente para aumentar el flujo, o las teclas   para disminuirlo.</p> <p>Permite configurar:</p> <ul style="list-style-type: none"> • Memoria= la bomba tiene una función de memoria, que señala la recepción de una señal durante la dosificación. Si está configurado en Off, envía una señal; si está configurado en On envía una señal y memoriza los impulsos, después los ejecuta cuando ha terminado de recibir las señales. • 1:N= Con cada señal recibida, la bomba realiza 1 segundo en la "N" programada (por ej: 20%) de velocidad.

Caso Modo N :1





La bomba dosifica el número de impulsos siguiente a la entrada relativa.
Un impulso de entrada N genera 1 segundo de dosificación a 1%
por ej.

- Si N está configurado en 1 (N=1) la bomba dosifica durante un segundo a una velocidad = 1% de la velocidad máx.
- Si N está configurado en 100 (N=100), la bomba espera por 100 impulsos y después dosifica durante un segundo a una velocidad = 1% de la velocidad máx.

versión	Dosificación promedio @ 1%*	Dosificación promedio @ 100%*
10000ml/h	0,027ml	2,77ml
2000ml/h	0,0055ml	0,55ml

* cantidad dosificada en 1 segundo







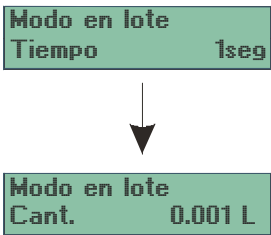

Si la velocidad de flujo calculada es mayor al máximo, la bomba se pone en la función MEM (si se lo selecciona) y dosifica la última cantidad, cuando es posible.

Programación	Funcionamiento
<div style="text-align: center;"> <div style="border: 1px solid black; background-color: #d9ead3; padding: 5px; width: fit-content; margin: 0 auto;">N :1 MODO Memoria Off</div> <div style="text-align: center; margin: 10px 0;">↓</div> <div style="border: 1px solid black; background-color: #d9ead3; padding: 5px; width: fit-content; margin: 0 auto;">N :1 MODO 1:1</div> </div>	<p>La bomba dosifica en proporción a una señal externa (por ej, mesa de lanzamiento impulsos). Con cada señal "N" programada recibida, la bomba realiza 1 segundo a 1% de la velocidad máxima.</p> <p>El valor "N" puede modificarse durante el funcionamiento, presionando las teclas   contemporáneamente para aumentar el flujo, o las teclas   para disminuirlo.</p> <p>Permite configurar:</p> <ul style="list-style-type: none"> • Memoria= la bomba tiene una función de memoria, que señala la recepción de una señal durante la dosificación. Si está configurado en Off, envía una señal; si está configurado en On envía una señal y memoriza los impulsos, después los ejecuta cuando ha terminado de recibir las señales. • N:1= Con cada señal "N" programada recibida, la bomba realiza 1 segundo a 1% de la velocidad máxima.

Caso Modo Batch:

La bomba dosifica la cantidad seleccionada cuando se presiona el botón UP o cuando se lee un impulso en la entrada (otros impulsos son ignorados cuando la bomba está dosificando) o si se seleccionan las señales del disparador, cuando se lee en la entrada una señal válida del disparador.

Si el tiempo de dosificación seleccionado es demasiado corto, la bomba dosifica a la velocidad máxima de flujo.

Programación	Funcionamiento
	<p>La bomba dosifica en proporción a una señal externa (por ej, mesa de lanzamiento impulsos). En este caso, se puede configurar la cantidad a dosificar en l y el tiempo dentro del cual completar la dosificación.</p> <p>La dosificación puede iniciar automáticamente presionando la tecla  o usando un control a distancia. La tecla  interrumpe la dosificación. La dosificación realizada puede resetearse presionando la tecla  o iniciarse una vez más presionando la tecla  nuevamente.</p> <p>La cantidad a dosificar puede modificarse durante el funcionamiento, presionando las teclas   contemporáneamente para aumentar el flujo, o las teclas   para disminuirlo.</p> <p>Permite configurar:</p> <ul style="list-style-type: none"> • Tiempo= el tiempo en segundos de terminación de la dosificación • Cant = la cantidad a dosificar en litros

Apartado 6

Esto permite configurar las funciones de la bomba del modo siguiente:

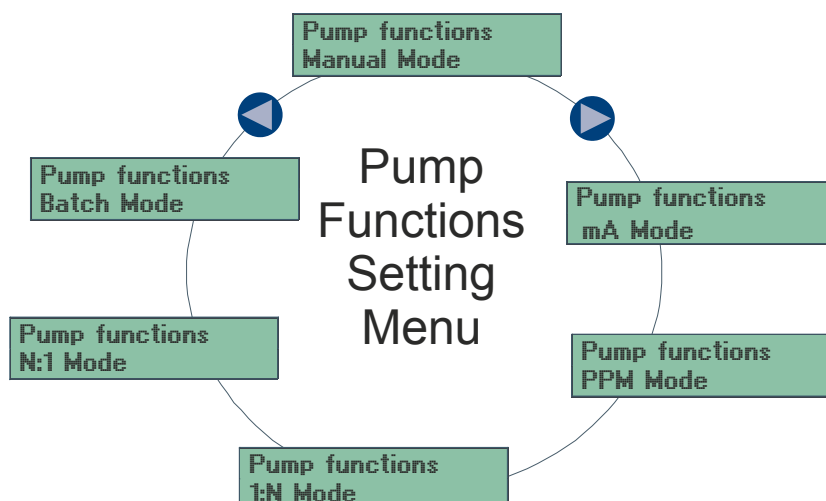

Apartado 7

Programación	Funcionamiento
Densidad 1.00 kg/L	Esto permite configurar la densidad del producto químico.

Apartado 8

Programación	Funcionamiento
Disparadores No Trg	Esto permite configurar la entrada disparadores. Cuando están presentes los disparadores, éstos otorgan la habilitación a la bomba para funcionar, dependiendo de la configuración de la función de la bomba: <ul style="list-style-type: none">• No Trg= los disparadores están deshabilitados.• Trg 1= la bomba funciona sólo cuando está habilitado el disparador 1.• Trg 2= la bomba funciona sólo cuando está habilitado el disparador 2.• Trg 1 y 2 = la bomba funciona sólo cuando están habilitados los disparadores 1 y 2.

Apartado 9

Programación	Funcionamiento
Unidades L/h	Permite configurar la unidad de medición, que puede ser: <ul style="list-style-type: none">• L/h= litro por hora.• ml/m= milímetro por minuto.• Gph= Galón por hora.• %= el porcentaje de la velocidad máxima de flujo.

Apartado 10

Programación	Funcionamiento
Zumbador Off (apagado)	El zumbador se activa cuando hay una condición de alarma. Esto permite configurar el zumbador del sistema en On u Off.

Apartado 11

Programación	Funcionamiento
Alarma nivel Parada	Esto permite configurar la alarma de nivel del modo siguiente: <ul style="list-style-type: none">• Stop= la bomba se detiene.• Run= la bomba sigue funcionando.

Apartado 12



Programación	Funcionamiento
<div style="border: 1px solid black; padding: 5px; background-color: #e0f2f1;"> Alarma relé N. Abierto </div>	Esto permite configurar la alarma relé del modo siguiente: <ul style="list-style-type: none"> • N.Open= normalmente abierto. • N.Closed= normalmente cerrado.



Apartado 13

Programación	Funcionamiento
<div style="border: 1px solid black; padding: 5px; background-color: #e0f2f1;"> Velocidad máx. de flujo 100% 10.000 L </div>	Permite configurar el flujo máximo ofrecido por la bomba y el modo programado (% o frecuencia) se usa como unidad estándar de medición al visualizar el flujo.



9. Mantenimiento

9.1 Cambio tubo

Con la bomba en **Stop** (presionar la tecla ) , presionando la tecla  durante 3 segundos la bomba funciona en sentido contrario a las agujas del reloj a la velocidad mínima para facilitar la extracción de la manguera, para terminar el funcionamiento de la bomba, presionar la tecla .

Con el mismo procedimiento presionando la tecla  durante 3 segundos la bomba funciona en el sentido de las agujas del reloj a la velocidad mínima para facilitar la sustitución de la manguera, para terminar el funcionamiento de la bomba, presionar la tecla .

9.2 Contraste LCD

Con la bomba en **Stop** (presionar la tecla ) , presionando la tecla  y la tecla  para aumentar o disminuir el contraste.

10. VISTA monitor

10.1 Durante la dosificación

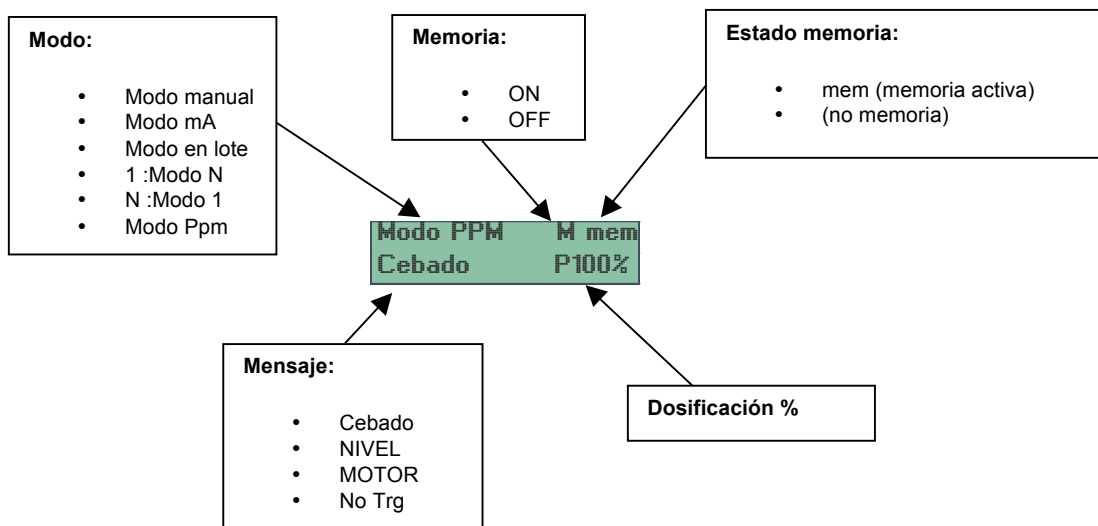

10.2 Durante la parada

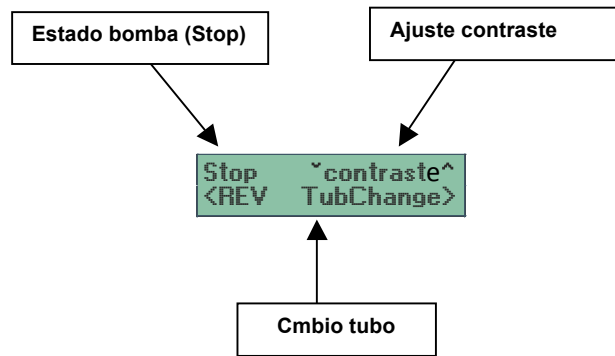

11. CONFIGURACIÓN RÁPIDA PARÁMETRO

Desde el modo de visualización de dosificación, presionando como mínimo durante 3 segundos la tecla  en la pantalla se verá el menú de configuración rápida:

```
Modo manual
Max % 100%
```

En este menú se pueden cambiar los siguientes ítems:

1) Velocidad máx. flujo en:

- Modo mA
- Modo manual

2) N en:



- 1 : Modo N
- N : Modo 1

3) Cantidad en:

- Modo en lote

4) ppm en:

- Modo ppm

Para modificar el valor actual mantener presionada  con  o las teclas .

12. Lista parámetros

	Parámetro	Valor	Valor	Valor	Valor	Valor	Valor	predeterminado
1	Idiomas	Inglés	Alemán	Italiano				Inglés
2	Password	0 - 9999						0 (deshabilitado)
3	Estadística	horas dosificación	horas tubos	litros				
4	Velocidad máx. de flujo	0.1 – 100.0%						100,0%
5	Función bomba	Modo manual	mA Modo	Modo en lote	1 :N Modo	N :1 Modo	Ppm Modo	Modo manual
6	Alarma relé	N. Open	N.Closed					N. Abierto
7	Alarma nivel	Parada	Run					Parada
8	Zumbador	ON	OFF (Apagado)					OFF (Apagado)
9	Unidad	ml/h	L/h	%				ml/h
10	Disparador	No Trg	Trg 1	Trg 2	Trg 1 2			No Trg
11	Densidad	0.50-2.00						1,00
12	En tiempo	0-10000						10
13	Tiempo Off	0-10000						0
14	Tiempo Retardo	0-10000						0
15	mA para 0%	0,0-20,0						4,0
16	mA para máx.	0,0-20,0						20,0
17	N	1-1000						1
18	impulso	1-2000						1
19	litro	1-2000						1
20	QUIM. CONC.	1-100						100
21	ppm	0-10000						1000
22	memoria	ON	OFF (Apagado)					OFF (Apagado)
23	Cantidad	0-30000						1
24	tiempo	0-10000						1
25	Velocidad flujo	Calibr.						10000

13. Tabla parámetros dosificación

Modo	Param 1	Param 2	Param 3	Memoria	Disparador	Velocidad máx. de flujo	Densidad
Manual	Puntualidad seg (0-10000)	OFF Tiempo seg (0-10000)	Tiempo RETARDO seg (0-10000)		Disparador (No Trg /Trg 1/Trg 2/Trg 1&2)	Velocidad máx. de flujo (0.1 – 100 %)	
Directo o inverso mA	mA Entrada para dosificación mín. (0.0-20.0 mA)	mA Entrada para dosificación máx. (0.0- 20.0 mA)			Disparador (No Trg /Trg 1/Trg 2/Trg 1&2)	Velocidad máx. de flujo (0.1 – 100 %)	
PPM	Punto de ajuste (1-3000 ppm)	Factor flujómetro (1-2000 impul / 1-2000 Lit)	QUIM. CONC. (1-100 %)	MEMORIA (ON- OFF)	Disparador (No Trg /Trg 1/Trg 2/Trg 1&2)		DENSIDAD (0.50 – 2.00 kg/L) 1,00
Batch	Cantidad (1-30000 ml)	Tiempo seg (1-10000)		MEMORIA (ON- OFF)			DENSIDAD (0.50 – 2.00 kg/L) 1,00
PROP 1:N	N (1-1000)			MEMORIA (ON- OFF)	Disparador (No Trg /Trg 1/Trg 2/Trg 1&2)		
PROP N:1	N (1-1000)			MEMORIA (ON- OFF)	Disparador (No Trg /Trg 1/Trg 2/Trg 1&2)		

Los parámetros predeterminados están escritos en negrita y subrayado

14. Tabla alarmas

Alarma	dosificación	Display	Zumbador	Relé
FRENO TUBO	Parada	FRENO TUBO	ON si se ha seleccionado	ON si se ha seleccionado
Nivel	Stop si se ha seleccionado	NIVEL	ON si se ha seleccionado	ON si se ha seleccionado
Motor	Parada	MOTOR	ON si se ha seleccionado	ON si se ha seleccionado

1. INFORMATIONS DE SÉCURITÉ

Explication des informations de sécurité



Attention – haute tension



Attention – surface chaude



Attention – zone de danger

Utilisation conforme

- La pompe ne doit être utilisée que pour mesurer des produits chimiques liquides.
- Le système doit être utilisé conformément aux données techniques et aux spécifications mises en évidence dans le Manuel de fonctionnement.
- La pompe ne peut être utilisée qu'à condition d'avoir été installée et mise en service correctement.
- Toute autre utilisation ou modification est interdite.
- La pompe n'est pas conçue pour mesurer les produits gazeux ou les solides.
- La pompe ne peut être utilisée à l'extérieur sans protection supplémentaire (revêtement, toit de protection contre les intempéries).
- La pompe ne peut être utilisée que par du personnel formé et autorisé, voir le tableau suivant.
- Les informations contenues dans les instructions de fonctionnement doivent être strictement respectées à chaque étape de la durée de vie du système.

Personnel technique

Un employé qualifié est une personne qui est à même d'évaluer les tâches qui lui sont assignées et d'identifier des risques potentiels, grâce à sa formation, ses connaissances et son expérience techniques, ainsi qu'à sa connaissance des réglementations concernées.

Electricien

Les électriciens sont des personnes à même d'effectuer des travaux sur des systèmes électriques et d'identifier et éviter des risques potentiels grâce à leur formation et à leur expérience technique, ainsi qu'à leur connaissance des réglementations et normes concernées. Les électriciens doivent être spécialement formés pour l'environnement de travail dans lequel ils exercent et connaître les réglementations et les normes concernées. Les électriciens doivent respecter les dispositions des directives statutaires applicables sur la prévention des accidents.

Personnel formé

Une personne formée est une personne qui a été instruite et, si nécessaire, formée aux tâches qui lui ont été assignées et aux dangers possibles qui pourraient découler d'une attitude inappropriée, mais à qui ont été également enseignés les équipements et les mesures de protection nécessaires.

Equipement de protection

Le couvercle transparent sur la tête doseuse sert à empêcher que des personnes ne touchent le rotor en mouvement et à éviter la fuite d'un fluide de dosage en cas de rupture d'un flexible.

Informations en cas d'urgence

Débrancher la fiche secteur ou presser l'un des boutons d'arrêt d'urgence, si présent, en cas d'urgence.

Si un produit chimique fuit, il est aussi nécessaire de dépressuriser le système hydraulique autour de la pompe. Respecter la fiche de données de sécurité pour les produits chimiques.

2. À PROPOS DE CE PRODUIT

Le produit **Kronos** est une pompe de dosage péristaltique actionnée par un moteur pas-à-pas. Le produit chimique est transporté par le rotor exerçant une pression sur le flexible. Aucune vanne n'est nécessaire pour cela. Cela garantit un traitement délicat du fluide dosé.

Les applications typiques sont celles des processus pour lesquels seule une faible pression de refoulement est requise, comme pour le dosage de produits chimiques dans des bains galvaniques, dans des bacs de décantation ou pour le dosage d'agents de conditionnement dans des piscines (floculants, charbon actif et produits chimiques).

Le logement est réalisé en PPE antichoc et résistant aux produits chimiques avec un degré de protection IP65.

Il est équipé de plusieurs entrées pour la configuration du dosage. Le moteur pas-à-pas permet de régler le dosage à l'infini.

Aperçu général des caractéristiques principales :

- Alimentation 100÷240 Vac 50/60 Hz
- Plage de débit :
 - 0.010 ÷ 10.00 l/h à 2bar or 0.002 ÷ 02.00 l/h à 3bar
 - Matériau du flexible SekoExtra or SekoMed (autre sur demande)
 - 0.008 ÷ 8.00 l/h à 3bar or 0.003 ÷ 03.00 l/h à 6bar
 - Matériau du flexible SekoTech
- Moteur pas-à-pas puissant, vitesse configurable
- Réglage infini du débit de dosage aussi bien manuellement que de l'extérieur via les signaux 0/4-20 mA
- Fonction d'amorçage (fonctionnement à grande vitesse)
- Affichage du débit de dosage sur l'écran en l/h, ml/m, Gph ou %.
- Sens réversible
- Degré de protection du logement IP65
- Système de rupture du tube
- Fusible 1,6A (20W)

3. DIMENSIONS ET APERCU DU PRODUIT

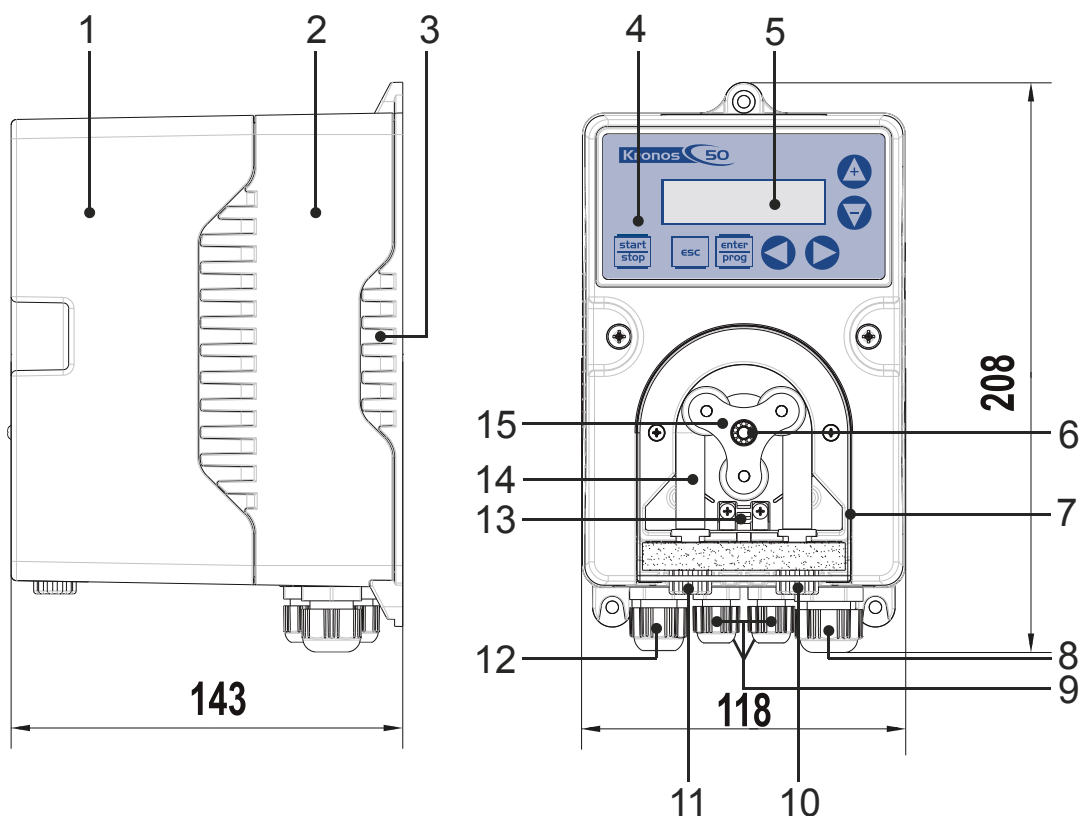

1	Logement : section supérieure	9	Circuits imprimés 7
2	Logement : section centrale	10	Connecteur de refoulement
3	Logement : section inférieure	11	Connecteur d'aspiration
4	Touches de commande	12	Circuit imprimé 9
5	Ecran LCD	13	Contrôle rupture flexible
6	Roulement à billes	14	Flexible de pompe
7	Couvercle transparent	15	Rotor
8	Circuit imprimé 11		

4. DESIGN ET DESCRIPTION FONCTIONNELLE

La pompe est composée de deux éléments principaux :

- Unité d'entraînement (moteur pas-à-pas)
- Tête doseuse (rotor, galets et flexible de pompe)

Unité de fonctionnement

L'appareil est abrité dans un logement en plastique robuste. Le logement en plastique est composé d'une section supérieure et d'une section inférieure, qui sont vissées ensemble. La section inférieure contient les circuits imprimés pour l'alimentation et les connecteurs.

La section supérieure du logement abrite l'unité centrale, le moteur et l'affichage des circuits imprimés avec écran et boutons.

La tête doseuse est montée à l'avant et est fermée par un couvercle transparent vissé pour la protéger et éviter tout endommagement. Le flexible de pompe peut facilement être changé une fois que le couvercle transparent a été retiré.

Le mouvement de rotation des rotors presse et relâche tour à tour le flexible de pompe à l'aide de trois galets. Le liquide est ainsi aspiré à l'intérieur et transporté à travers le flexible de pression.

La pompe est actionnée par l'unité de fonctionnement. Le niveau et le mode de dosage désirés sont configurés avec. L'opération de dosage est contrôlée par l'unité de fonctionnement ou via un contact externe, l'entrée de niveau.

5. INSTALLATION

1. Marquer les emplacements des trous sur le mur
2. Percer les trous \varnothing 8 mm et introduire les goujons fournis
3. Fixer le support au mur
4. Accrocher l'appareil dessus

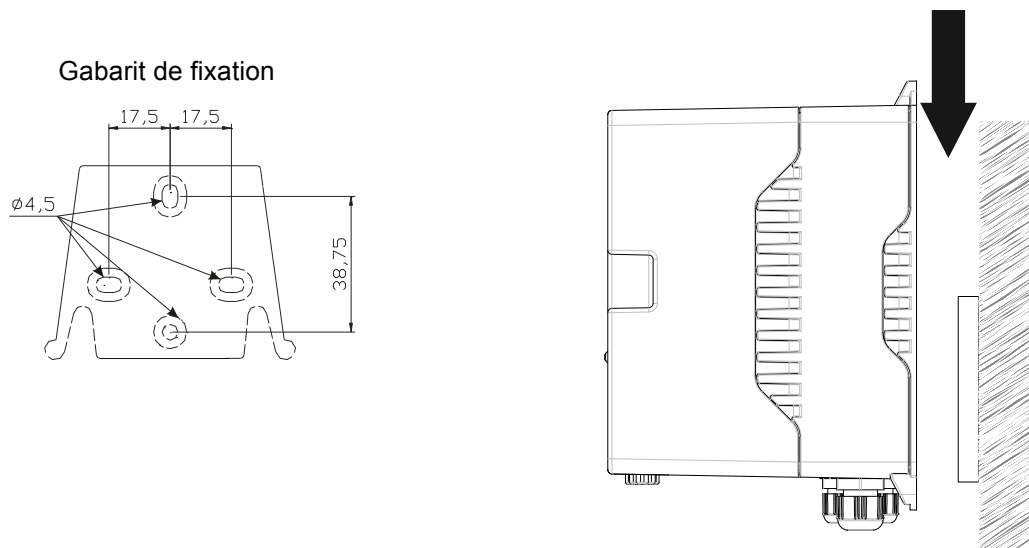

6. INSTALLATION HYDRAULIQUE

Monter les lignes d'aspiration et de refoulement :

1. Couper les extrémités des flexibles de façon à ce qu'elles soient droites.
2. Visser l'écrou borgne et le glisser sur le flexible.
3. Visser le tuyau terminal jusqu'à ce qu'il s'arrête par dessus la buse.
4. Raccorder la ligne de refoulement au raccord droit du flexible.
5. Raccorder la ligne d'aspiration au raccord gauche du flexible.
6. Resserrer les écrous borgnes.
7. Pour ce faire, raccourcir l'extrémité libre de la ligne d'aspiration de façon à ce que l'extrémité se trouve juste au-dessus du fond du conteneur.
8. Si nécessaire, alimenter un tuyau depuis le raccord de fuite jusqu'au conteneur.

7. INSTALLATION ELECTRIQUE

1. Poser un câble d'alimentation avec protection contre les courts-circuits et interrupteur secteur, si nécessaire, avec interrupteur d'arrêt d'urgence.
2. S'assurer que le câble d'alimentation secteur reste bien hors tension !
3. Percer le petit trou tout à droite sur le côté inférieur de la section arrière à l'aide d'un tournevis.
4. Visser la vis correspondante et serrer, et non la vis de perçage.
5. Introduire les inserts de réduction selon le diamètre du câble utilisé et introduire l'assemblage fileté.
6. Alimenter le câble secteur dans l'assemblage fileté.
7. Brancher le câble secteur à la plaque à bornes.
8. Serrer la vis de serrage de façon à ce que le montage fileté soit résistant à l'humidité.

6.1 Raccordements électriques

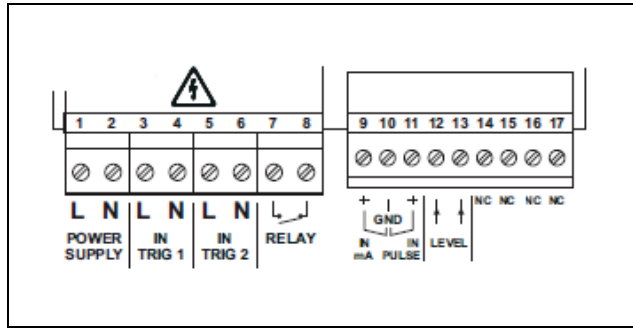











Numéro borne	Description	Caractéristiques électriques	
1 - 2	Alimentation électrique	100÷240 VAC (50–60Hz)	
3 - 4	Trigger 1 signal d'entrée	24÷240 VAC ou VDC	
5 - 6	Trigger 2 signal d'entrée	24÷240 VAC ou VDC	
7 - 8	Sortie relais alarme	250VAC 8A	
9 - 10	9 Pôle + (mA)	Entrée mA	0/4÷20 mA (Impédance d'entrée : 200 ohm)
	10 Pôle - (MISE A LA TERRE)		
10 - 11	10 Pôle - (MISE A LA TERRE)	Entrée impulsions	Impulsions sans tension (compteur d'émission d'impulsion ; contact sec : on-off, fréquence max. 1 KHz)
	11 Pôle + (impulsion)		
12 - 13	Entrée sonde de contrôle de niveau	Contact sec (on-off)	
14 -15 -16 -17	Non utilisé	Non utilisé	

8. UNITE DE FONCTIONNEMENT

8.1 Touches de commande





Les touches de commande sont désignées comme suit :

Touche	Description
	Démarre et arrête la pompe. En cas d'alarme de niveau (fonction alarme seulement), d'alarme de flux et d'alarme de mémoire active, elle permet de désactiver le signal sur l'écran.
	Touche utilisée pour sortir des différents niveaux du menu. Avant de quitter définitivement une phase de programmation, il vous sera demandé si vous souhaitez sauvegarder les modifications.
	Lorsque cette touche est pressée pendant la phase d'exploitation de la pompe, elle permet d'afficher sur l'écran de façon cyclique les valeurs programmées. La pression simultanée de la touche  ou  permet d'augmenter ou de diminuer une valeur selon le mode de fonctionnement sélectionné. Lors de la programmation, elle exécute la fonction "enter", c'est à dire qu'elle confirme l'entrée dans les différents niveaux de menu et les modifications à l'intérieur de ceux-ci.
	Touche utilisée pour parcourir le menu vers le haut.
	Touche utilisée pour parcourir le menu vers le bas ou pour l'amorçage, en la maintenant appuyée au moins 3 secondes, la pompe commence à fonctionner à 100 % jusqu'à ce que la touche  soit pressée.
	Touche utilisée pour augmenter les valeurs numériques à modifier. Peut être utilisée pour démarrer le dosage en mode Batch.
	Touche utilisée pour diminuer les valeurs numériques à modifier.





8.2 Menu de programmation

Vous pouvez accéder au menu de programmation en pressant la touche .

Les touches   peuvent être utilisées pour parcourir les différents points du menu, la touche  servant à accéder aux modifications.

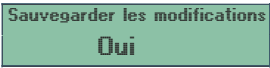

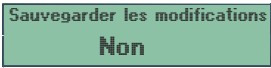

En usine, la pompe est programmée en mode constant. La pompe retourne automatiquement au mode de fonctionnement au bout d'une minute d'inactivité. Toute donnée saisie dans ces circonstances ne sera pas sauvegardée.

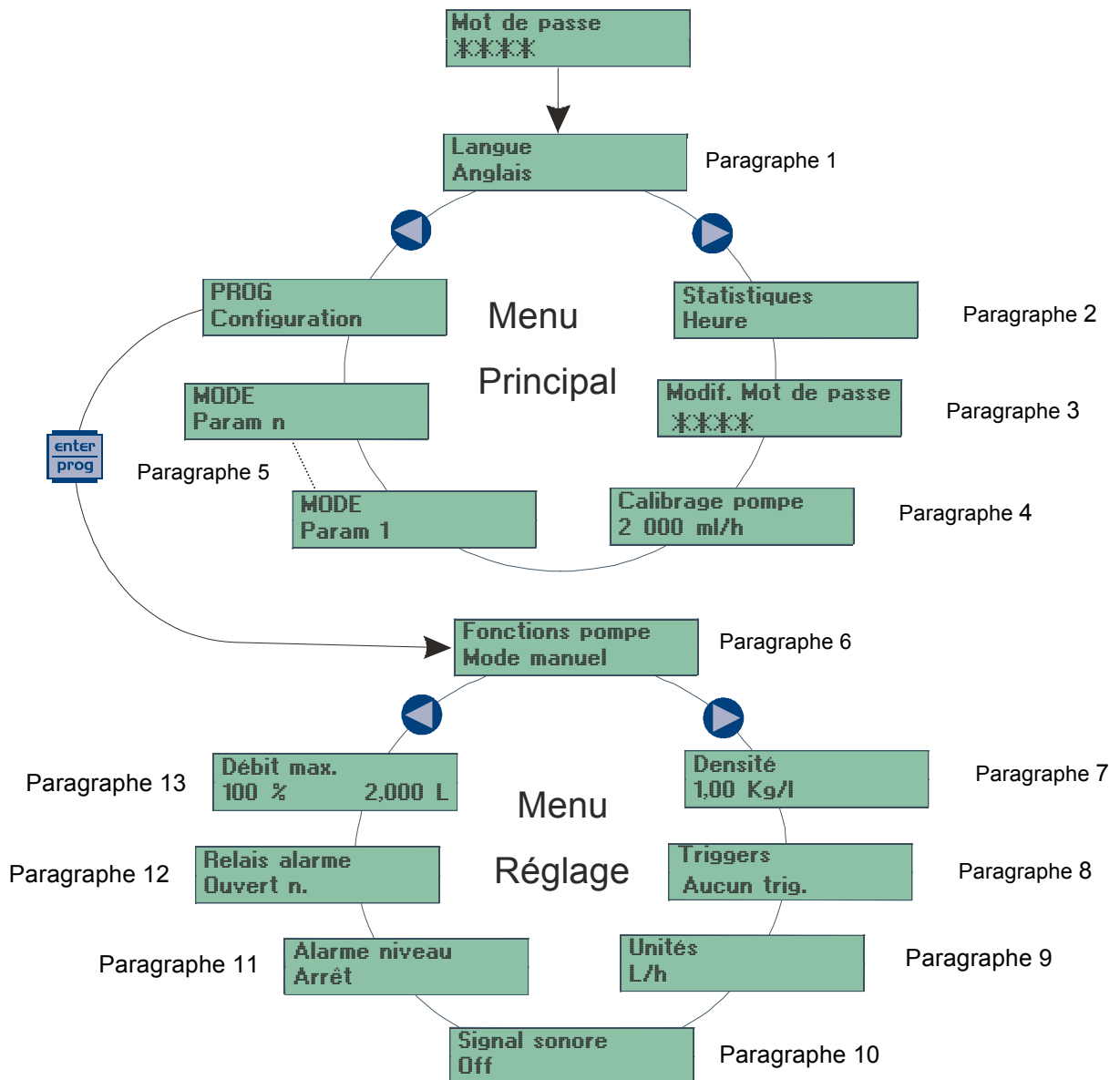
La touche  peut être utilisée pour sortir des différents niveaux de programmation. Au moment de quitter la programmation, l'écran affiche ceci :











 pour confirmer la sélection.







Paragraphe 1

Programmation	Opération
<div style="border: 1px solid black; background-color: #e0f2f1; padding: 5px; width: fit-content; margin: 10px auto;">Langue Anglais</div>	<p>Permet de sélectionner la langue. En usine, la pompe est configurée en anglais. Les modifications peuvent être effectuées en pressant la touche , puis en utilisant les touches   pour régler la nouvelle valeur.</p> <p>Appuyer sur  pour confirmer et retourner au menu principal.</p>

Paragraphe 2





Programmation	Opération
<div style="border: 1px solid black; background-color: #e0f2f1; padding: 5px; width: fit-content; margin: 10px auto;">Statistiques Heure</div>	<p>Le menu principal affiche les temps de fonctionnement de la pompe. Presser la touche  permet d'accéder à d'autres statistiques :</p> <ul style="list-style-type: none"> - Heures tubage = temps de fonctionnement tubage. - Q.té (litres) = quantité dosée par la pompe en litres. - Réinitialiser = utiliser les touches   pour réinitialiser les compteurs (OUI) ou autre (NON), puis confirmer en pressant la touche . <p>Presser la touche  permet de retourner au menu principal.</p>

Paragraphe 3

Programmation	Opération
<div style="border: 1px solid black; background-color: #e0f2f1; padding: 5px; width: fit-content; margin: 10px auto;">Modif. Mot de passe ****</div>	<p>Permet de modifier le mot de passe d'accès. Les modifications peuvent être effectuées en pressant la touche , puis en utilisant les touches   pour régler la nouvelle valeur.</p> <p>Pour désactiver le mot de passe, saisir le code : 0000.</p> <p>Presser la touche  permet de retourner au menu principal.</p>

Paragraphe 4

Programmation	Opération
---------------	-----------

<div style="border: 1px solid black; padding: 5px; display: inline-block;">Calibrage 2000 ml/h</div>	<p>La pompe peut être calibrée comme suit :</p> <p>La pompe fonctionne à la vitesse maximale pendant 36 sec. (version 10 l/h) ou 180 sec. (version 2 l/h) , et démarre grâce à la pression de la touche  .</p> <p>A la fin de ce laps de temps, saisir la quantité aspirée par la pompe à l'aide des touches   et confirmer en pressant la touche  .</p> <p>Le nombre saisi sera utilisé pour les calculs de débit.</p>
--	---

Paragraphe 5

Ces articles de menu sont différents selon les

PROG
Configuration

 →

Fonction pompe
Mode manuel

 réglages du menu :

- **Mode manuel**
- **Mode mA**
- **Mode PPM**
- **Mode 1:N**
- **Mode N:1**
- **Mode Batch**

Exemple du **Mode manuel** :

La pompe dose selon le débit sélectionné. Si l'intervalle OFF est réglé sur 0 sec., la pompe fonctionne de façon continue.
La pompe démarre le dosage après un délai réglable.

Ex. : dosage manuel avec trigger :

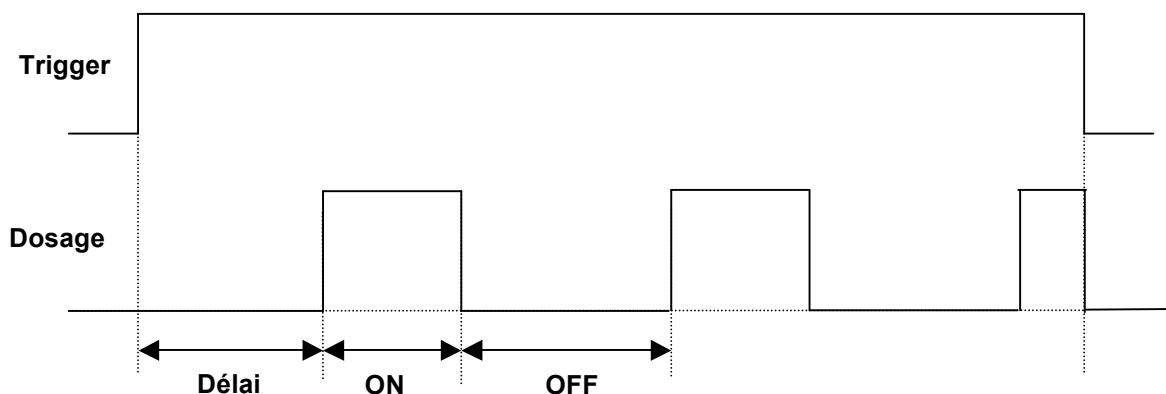

Si aucun trigger n'est sélectionné, la pompe commence le décompte du délai après l'allumage.

Programmation	Opération
	La pompe fonctionne en mode constant. Le débit ne peut

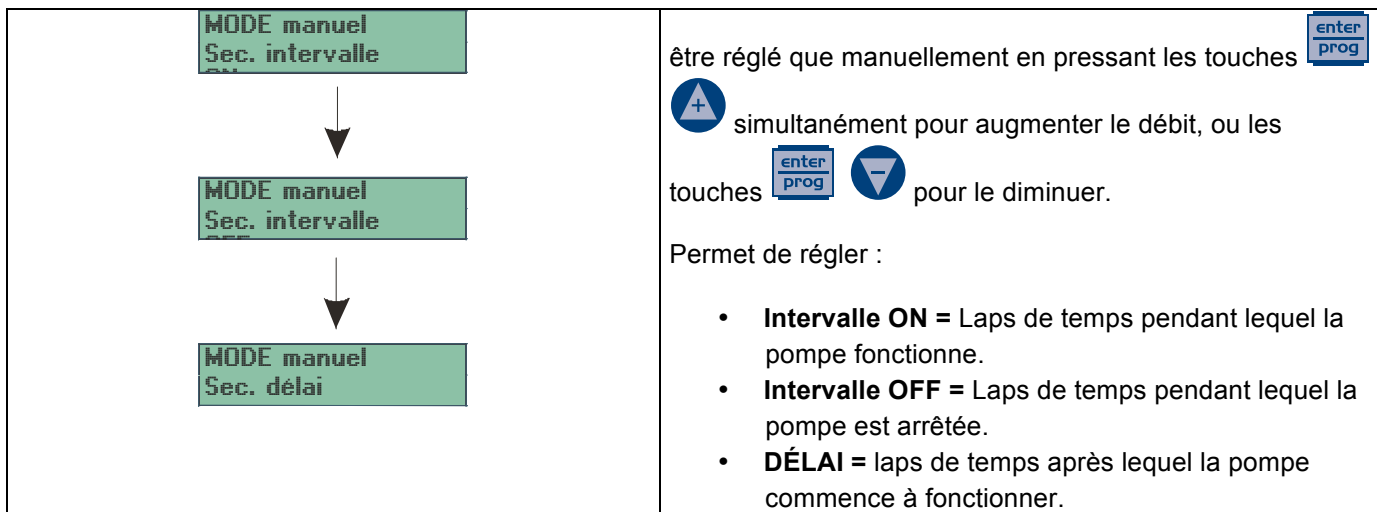

Exemple du Mode mA :

La pompe dose proportionnellement à un signal de (0)4-20 mA ou 20-4(0) mA. Il est possible de régler la valeur d'entrée mA correspondant à 0 % du dosage et la valeur d'entrée mA correspondant au débit maximum de la pompe.

Ex. : Dosage mA **direct** :

entrée mA pour 0 % = 5 mA

entrée mA pour DÉBIT MAX = 10 mA

Débit max. = 80 %

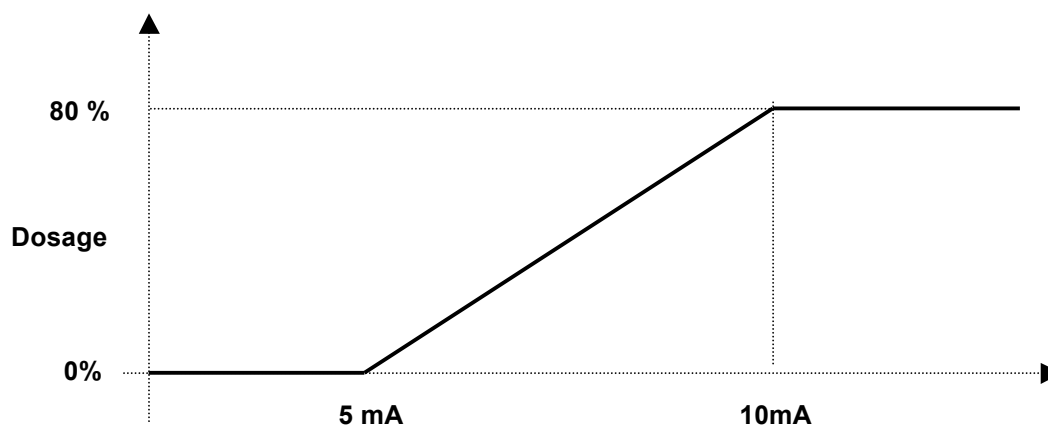



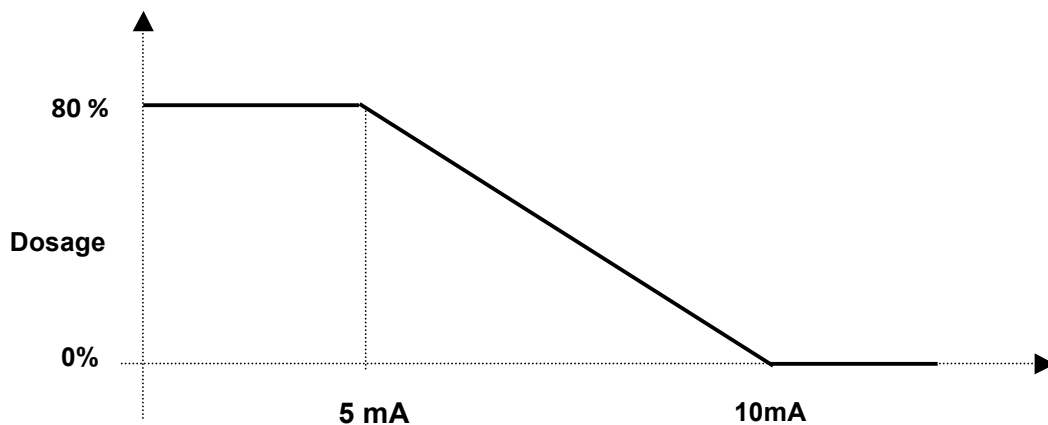

Ex. : Dosage mA **inverse** :

entrée mA pour 0 % = 10mA

entrée mA pour DÉBIT MAX = 5mA
 Débit max. = 80 %



Programmation	Opération
<div style="border: 1px solid black; padding: 5px; margin-bottom: 5px;"> MODE mA DOS. MAX. A </div> <div style="text-align: center;">↓</div> <div style="border: 1px solid black; padding: 5px;"> MODE mA 0 % DOS. A </div>	<p>La pompe dose proportionnellement à un signal de 0/4-20 mA. Sur la base des réglages d'usine, la pompe interrompt le dosage à 0 mA et dose à la fréquence maximum lorsqu'elle reçoit 20 mA. Ces deux valeurs peuvent être modifiées lors de la programmation. Les fréquences minimum et maximum peuvent être modifiées pendant le fonctionnement en pressant les touches </p> <p> simultanément pour augmenter le débit, ou les touches   pour le diminuer.</p>

Exemple du Mode PPM :

Afin de maintenir le ppm sélectionné du produit chimique, la pompe calcule le taux de dosage approprié à partir des paramètres suivants :



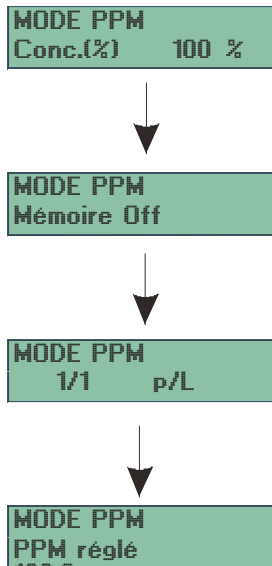

- Impulsion par minute sur entrée d'impulsion
- Facteur débitmètre (impulsion/litre)
- Densité du produit chimique
- Concentration du produit chimique

Si le débit calculé est plus important que le maximum, la pompe entre en fonction MEM (si sélectionnée) et dose la quantité durable lorsque c'est possible.

Programmation	Opération
---------------	-----------



La pompe dose proportionnellement à un signal externe (par ex. : compteur de lancement d'impulsions), calculant automatiquement le rapport entre signaux entrant et vitesse de la pompe sur la base de la valeur ppm programmée.

La fréquence de dosage peut être modifiée pendant le fonctionnement en pressant les touches   simultanément pour augmenter le débit, ou les touches   pour le diminuer.

Permet de régler :

- **Conc.(%)** = concentration du produit
- **Mémoire** = la pompe dispose d'une fonction mémoire, qui informe de la réception d'un signal pendant le dosage. Si elle est réglée sur Off, elle envoie simplement un signal, si elle est réglée sur On elle envoie un signal et mémorise les impulsions, puis les exécute lorsqu'elle ne reçoit plus de signaux.
- **1/1** = nombre d'impulsions par litre (1/1-999/999) et par conséquent le système dose selon les valeurs réglées.
- **PPM réglé** = valeur ppm que le système va doser.

Exemple Mode 1:N :

La pompe dose en suivant le nombre d'impulsions de l'entrée concernée.
 One impulsion d'entrée génère 1 seconde de dosage à la vitesse réglée (N)
 Par ex. :

- Si N est réglé sur 1 (N = 1), la pompe dose pendant une seconde à la vitesse = 1 % de la vitesse max.
- Si N est réglé sur 100 (N = 100), la pompe dose pendant une seconde à la vitesse = 100% de la vitesse max.

version	Dosage moyen à 1 %*	Dosage moyen à 100%*
10 000 ml/h	0,027 ml	2,77ml
2 000 ml/h	0,0055ml	0,55ml

* quantité dosée en 1 seconde

Si le débit calculé est plus important que le maximum, la pompe entre en fonction MEM (si sélectionnée) et dose la quantité durable lorsque c'est possible.

Programmation	Opération
---------------	-----------

La pompe dose proportionnellement à un signal externe (par ex. : compteur de lancement d'impulsions). A chaque signal reçu, la pompe réalise 1 seconde à la vitesse "N" programmée (par ex. : 20 %).

La valeur de "N" peut être modifiée pendant le fonctionnement en pressant les touches simultanément pour augmenter le débit, ou les touches pour le diminuer.

Permet de régler :

- **Mémoire** = la pompe dispose d'une fonction mémoire, qui informe de la réception d'un signal pendant le dosage. Si elle est réglée sur Off, elle envoie simplement un signal, si elle est réglée sur On elle envoie un signal et mémorise les impulsions, puis les exécute lorsqu'elle ne reçoit plus de signaux.
- **1:N** = A chaque signal reçu, la pompe réalise 1 seconde à la vitesse "N" programmée (par ex. : 20 %).

Exemple mode N:1 :

La pompe dose en suivant le nombre d'impulsions de l'entrée concernée. Les impulsion d'entrée N génèrent 1 seconde de dosage à 1 %.

Par ex. :

- Si N est réglé sur 1 (N = 1), la pompe dose pendant une seconde à la vitesse = 1 % de la vitesse max.
- Si N est réglé sur 100 (N = 100), la pompe attend 100 impulsions et dose pendant une seconde à la vitesse = 1 % de la vitesse max.

version	Dosage moyen à 1 %*	Dosage moyen à 100%*
10000ml/h	0,027ml	2,77ml
2 000 ml/h	0,0055ml	0,55ml

* quantité dosée en 1 seconde







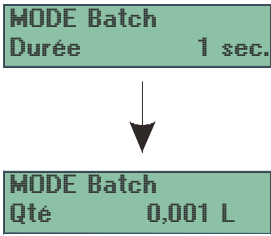

Si le débit calculé est plus important que le maximum, la pompe entre en fonction MEM (si sélectionnée) et dose la quantité durable lorsque c'est possible.

Programmation	Opération
	<p>La pompe dose proportionnellement à un signal externe (par ex. : compteur de lancement d'impulsions). A chaque signal "N" programmé reçu, la pompe réalise 1 seconde à 1 % de la vitesse max.</p> <p>La valeur de "N" peut être modifiée pendant le fonctionnement en pressant les touches simultanément pour augmenter le débit, ou les touches pour le diminuer.</p> <p>Permet de régler :</p> <ul style="list-style-type: none"> • Mémoire = la pompe dispose d'une fonction mémoire, qui informe de la réception d'un signal pendant le dosage. Si elle est réglée sur Off, elle envoie simplement un signal, si elle est réglée sur On elle envoie un signal et mémorise les impulsions, puis les exécute lorsqu'elle ne reçoit plus de signaux. • N:1 = A chaque signal "N" programmé reçu, la pompe réalise 1 seconde à 1 % de la vitesse max.

Exemple du Mode Batch :

La pompe dose la quantité sélectionnée lorsque le bouton UP est appuyé ou lorsque une impulsion est lue sur l'entrée (d'autres impulsions sont ignorées lorsque la pompe est en train de doser) ou si les signaux trigger sont sélectionnés, lorsqu'un signal trigger valide est lu sur l'entrée.

Si la durée sélectionnée pour le dosage est trop court, la pompe dose avec le débit maximum.

Programmation	Opération
 <p>The diagram shows two green boxes. The top box contains 'MODE Batch' and 'Durée 1 sec.'. An arrow points down to a second box containing 'MODE Batch' and 'Qté 0,001 L'.</p>	<p>La pompe dose proportionnellement à un signal externe (par ex. : compteur de lancement d'impulsions). Dans ce cas, il est possible de régler la quantité à doser en litres et la durée du dosage.</p> <p>Le dosage peut être démarré manuellement en pressant la touche , ou à l'aide d'une commande à distance. La touche  interrompt le dosage. Le dosage déjà effectué peut être réinitialisé en pressant la touche , ou en démarrant à nouveau en pressant une nouvelle fois la touche .</p> <p>La quantité à doser peut être modifiée pendant le fonctionnement en pressant les touches   simultanément pour augmenter le débit, ou les touches   pour le diminuer.</p> <p>Permet de régler :</p> <ul style="list-style-type: none"> • Durée = durée de dosage exprimée en secondes • Qté = quantité à doser exprimée en litre

Paragraphe 6

Permet de régler les fonctions de la pompe comme suit :

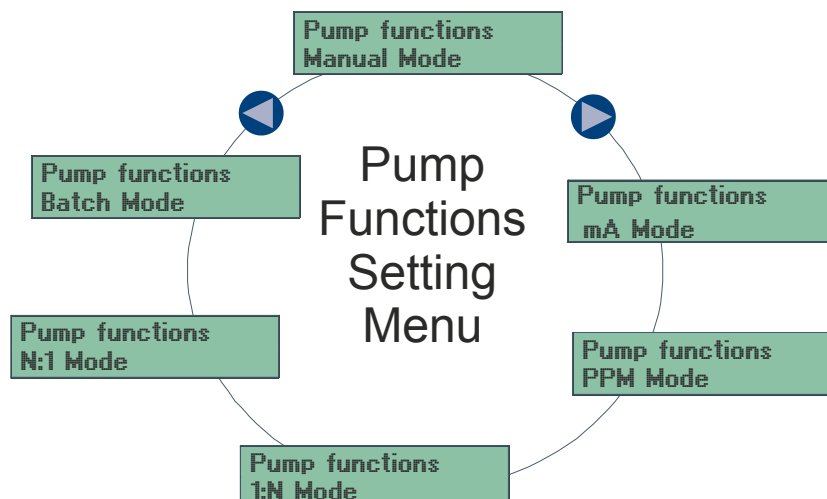

Paragraphe 7

Programmation	Opération
Densité 1.00 kg/L	Permet de régler la densité du produit chimique.

Paragraphe 8

Programmation	Opération
Triggers Aucun trig.	Permet de régler les triggers d'entrée. Lorsque les triggers sont présents, ils permettent à la pompe de fonctionner, selon la fonction de la pompe réglée : <ul style="list-style-type: none">• Aucun trig = les triggers sont désactivés.• Trig 1 = la pompe fonctionne seulement lorsque le trigger 1 est activé.• Trig 2 = la pompe fonctionne seulement lorsque le trigger 2 est activé.• Trig 1&2 = la pompe fonctionne lorsque les deux triggers (1&2) sont activés.

Paragraphe 9

Programmation	Opération
Unités L/h	Permet de régler l'unité de mesure, qui peut s'exprimer en : <ul style="list-style-type: none">• L/h = litre par heure.• ml/m = millilitre par minute.• Gph = gallon par heure.• % = le pourcentage du débit maximum.

Paragraphe 10

Programmation	Opération
Signal sonore Off	Le signal sonore est actif lorsqu'il y a une condition d'alarme. Permet de régler le signal sonore, On ou Off.

Paragraphe 11

Programmation	Opération
Alarme niveau Arrêt	Permet de régler l'alarme de niveau comme suit : <ul style="list-style-type: none">• Arrêt = la pompe s'arrête.• Marche = la pompe continue de fonctionner.

Paragraphe 12



Programmation	Opération
<div style="border: 1px solid black; padding: 5px; background-color: #e0f2f1;">Relais alarme Ouvert n.</div>	Permet de régler le relais d'alarme : <ul style="list-style-type: none"> • Ouvert n = ouvert normalement. • Fermé n = fermé normalement.



Paragraphe 13

Programmation	Opération
<div style="border: 1px solid black; padding: 5px; background-color: #e0f2f1;">Débit max. 100 % 10,000 L</div>	Permet de régler le débit maximum proposé par la pompe, et le mode programmé (% ou fréquence) est utilisé comme l'unité standard de mesure lors de l'affichage du débit.



9. Entretien

9.1 Changement tubage

Lorsque la pompe est à l'**arrêt** (presser la touche ) , en pressant la touche  pendant au moins 3 secondes la pompe fonctionne dans le sens inverse des aiguilles d'une montre à la vitesse minimum afin de faciliter le retrait du flexible, pour interrompre le fonctionnement de la pompe presser la touche  .

En suivant la même procédure, en pressant la touche  pendant au moins 3 secondes la pompe fonctionne dans le sens des aiguilles d'une montre à la vitesse minimum afin de faciliter la mise en place du flexible, pour interrompre le fonctionnement de la pompe presser la touche  .

9.2 Contraste LCD

Avec la pompe à l'**arrêt** (presser la touche ) , en pressant les touches  et  pour augmenter ou réduire le contraste.

10. Affichage écran

10.1 Pendant le dosage

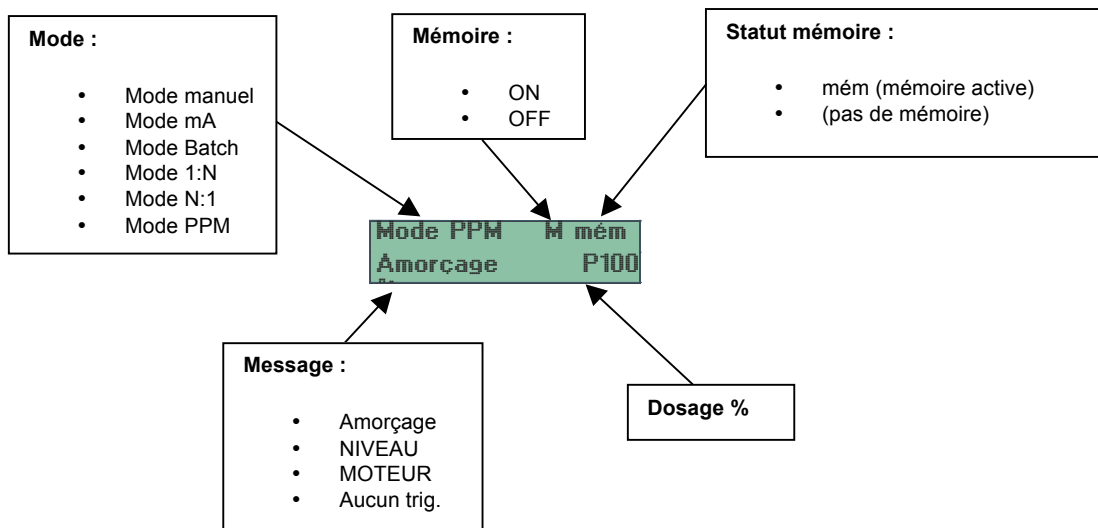

10.2 Pendant l'arrêt

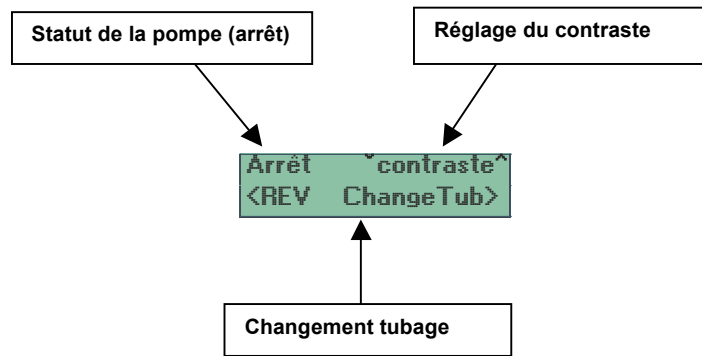

11. REGLAGE RAPIDE DE PARAMETRE

A partir du mode affichage du dosage, en pressant pendant au moins 3 secondes la touche , l'écran affiche le menu de réglage rapide :

```
Mode manuel
Max %      100%
```

Dans ce menu, vous pouvez modifier les points suivants :

1) Débit max. en :

- Mode mA
- Mode manuel

2) N en :



- Mode 1:N
- Mode N:1

3) Quantité en :

- Mode Batch

4) ppm en

- Mode ppm

Pour modifier la valeur actuelle, maintenir pressée la touche  avec la touche  ou .

12. Liste des paramètres

	Paramètre	Valeur	Valeur	Valeur	Valeur	Valeur	Valeur	Par défaut
1	Langue	anglais	allemand	italien				anglais
2	Mot de passe	0 - 9999						0 (désactivé)
3	Statistiques	heures dosage	heures tubage	litres				
4	Débit max.	0,1 – 100,0 %						100,0 %
5	Fonction pompe	Mode manuel	Mode mA	Mode Batch	Mode 1 :N	Mode N :1	Mode PPM	Mode manuel
6	Relais alarme	Ouvert n.	Fermé n.					Ouvert n.
7	Alarme niveau	Arrêt	Marche					Arrêt
8	Signal sonore	ON	OFF					OFF
9	Unité	ml/h	L/h	%				ml/h
10	Trigger	Aucun trig.	Trig 1	Trig 2	Trig 1&2			Aucun trig.
11	Densité	0,50-2,00						1,00
12	Intervalle On	0-10000						10
13	Intervalle Off	0-10000						0
14	Délai	0-10000						0
15	mA pour 0 %	0,0-20,0						4,0
16	mA pour max	0,0-20,0						20,0
17	N	1-1000						1
18	impulsion	1-2000						1
19	litre	1-2000						1
20	Conc. prod. chim.	1-100						100
21	ppm	0-10000						1000
22	mémoire	ON	OFF					OFF
23	quantité	0-30000						1
24	durée	0-10000						1
25	Débit	Calibr.						10000

13. Tableau paramètres de dosage

Mode	Param 1	Param 2	Param 3	Mémoire	Trigger	Débit max.	Densité
Manuel	Sec. intervalle ON (0-10000)	Sec. intervalle OFF (0-10000)	DÉLAI sec. (0-10000)		TRIGGER (Aucun Trig/Trig 1/Trig 2/Trig 1&2)	DÉBIT MAX. (0,1 –100 %)	
mA direct ou inversé	entrée mA pour dosage min. (0,0-20,0 mA)	entrée mA pour dosage max. (0,0-20,0 mA)			TRIGGER (Aucun Trig/Trig 1/Trig 2/Trig 1&2)	DÉBIT MAX. (0,1 –100 %)	
PPM	Point de réglage (1-3000 ppm)	Facteur débitmètre (1-2000 impuls. / 1-2 000 Lit)	CONC. PROD. CHIM. (1-100 %)	MÉMOIRE (ON-OFF)	TRIGGER (Aucun Trig/Trig 1/Trig 2/Trig 1&2)		DENSITÉ (0,50 – 2,00 kg/L) 1,00
Batch	Quantité (1-30 000 ml)	Durée sec. (1-10000)		MÉMOIRE (ON-OFF)			DENSITÉ (0,50 – 2,00 kg/L) 1,00
PROP 1:N	N (1-1000)			MÉMOIRE (ON-OFF)	TRIGGER (Aucun Trig/Trig 1/Trig 2/Trig 1&2)		
PROP N:1	N (1-1000)			MÉMOIRE (ON-OFF)	TRIGGER (Aucun Trig/Trig 1/Trig 2/Trig 1&2)		

Les paramètres par défaut sont inscrits en gras et sont soulignés

14. Tableau alarmes

alarme	dosage	Ecran	signal sonore	Relais
Rupture tube	arrêt	RUPTURE TUBE	ON si sélectionné	ON si sélectionné
Niveau	Arrêt si sélectionné	NIVEAU	ON si sélectionné	ON si sélectionné
Moteur	arrêt	MOTEUR	ON si sélectionné	ON si sélectionné

1. ISTRUZIONI DI SICUREZZA

Spiegazione delle istruzioni di sicurezza.



Attenzione – alta tensione



Attenzione – superficie calda



Attenzione – zona di pericolo

Uso corretto e indicato

- Usare la pompa solo per dosare i liquidi chimici di rabbocco.
- Usare il sistema conformemente ai dati e alle specifiche tecniche evidenziate nel Manuale Operativo.
- Usare la pompa solo se correttamente installata e messa in servizio.
- Utilizzi diversi o modifiche sono espressamente vietate.
- La pompa non è stata concepita per dosare mezzi gassosi o solidi.
- La pompa non può essere utilizzata all'aperto senza protezioni aggiuntive (coperture, tetto per la protezione dalle intemperie).
- La pompa dovrà essere azionata solo da personale autorizzato ed addestrato, si veda la tabella in basso.
- L'operatore è tenuto a rispettare le informazioni contenute nelle istruzioni operative durante le diverse fasi della vita utile del sistema.

Personale tecnico

Con personale qualificato s'intende un tecnico in grado di valutare gli incarichi assegnatigli e di riconoscere i possibili rischi sulla base dell'addestramento tecnico ricevuto, delle conoscenze e dell'esperienza maturata, ma anche sulla base della conoscenza delle normative applicabili.

Elettricista

Con elettricista s'intende un tecnico in grado di completare i lavori sui sistemi elettrici e di riconoscere ed impedire autonomamente eventuali rischi sulla base dell'addestramento e dell'esperienza tecnica maturata, ma anche della conoscenza degli standard e delle normative applicabili. Gli elettricisti dovrebbero ricevere un training specifico per l'ambiente operativo in cui lavorano e conoscere gli standard e le normative applicabili. Gli elettricisti devono ottemperare ai provvedimenti delle direttive nazionali applicabili in materia di prevenzione degli incidenti.

Personale addestrato

Con personale addestrato s'intende il personale che ha ricevuto una formazione e, se richiesto, un training negli incarichi assegnatigli e sui possibili pericoli connessi con comportamenti non idonei, sulle attrezzature e le misure protettive richieste.

Attrezzature protettive

Il coperchio trasparente sulla testa dosatrice serve per impedire che le persone possano entrare in contatto con il rotore in movimento e che vengano misurate le perdite di liquido in caso di rottura del tubo.

Informazioni in caso di emergenza

Scollegare l'alimentazione di rete o premere uno dei pulsanti per l'arresto di emergenza, laddove presenti, in caso di emergenza.

In caso di fuoriuscita del liquido chimico di rabbocco, depressurizzare il sistema idraulico attorno alla pompa. Osservare la scheda di dati di sicurezza per il prodotto chimico di rabbocco.

2. INFORMAZIONI SUL PRODOTTO

Kronos è una pompa dosatrice peristaltica azionata da un motore passo-passo. Il liquido chimico di rabbocco viene trasportato grazie al motore che preme sul tubo. Non sono richieste valvole. Questo assicura che il mezzo dosato sia trattato delicatamente.

Questo tipo di pompa viene generalmente impiegata nei processi che richiedono una pressione di scarico bassa, come il dosaggio di prodotti chimici nei bagni galvanici, nei serbatoi di chiarificazione o per dosare i condizionanti nelle piscine (flocculanti, carbone attivo e chimici).

L'alloggio è realizzato in PPE resistente agli agenti chimici e a prova d'urto con classe di protezione IP65.

È dotata di diversi ingressi per la configurazione del dosaggio. Il motore passo-passo consente di regolare all'infinito il dosaggio.

Di seguito è fornita una panoramica delle caratteristiche principali:

- Alimentazione 100÷240 Vac 50/60 Hz
- Range di uscita:
 - 0.010 ÷ 10.00 l/h @ 2bar o 0.002 ÷ 02.00 l/h @ 3bar
 - Materiale del tubo SekoExtra o SekoMed (o altri materiali su richiesta)
 - 0.008 ÷ 8.00 l/h @ 3bar or 0.003 ÷ 03.00 l/h @ 6bar
 - Materiale del tubo SekoTech
- Motore passo-passo potente, velocità configurabile.
- Regolazione infinita dell'uscita di dosaggio, sia manualmente che esternamente attraverso i segnali 0/4-20 mA
- Funzione adescante (funzionamento ad alta velocità)
- Visualizzazione dell'uscita di dosaggio sul display in l/h, ml/m, grafico o %
- Inversione della direzione
- Classe di protezione dell'alloggio IP65
- Sistema d'interruzione del tubo
- Fusibile 1,6 A (20 W)

3. DIMENSIONI E PANORAMICA DEL DISPOSITIVO

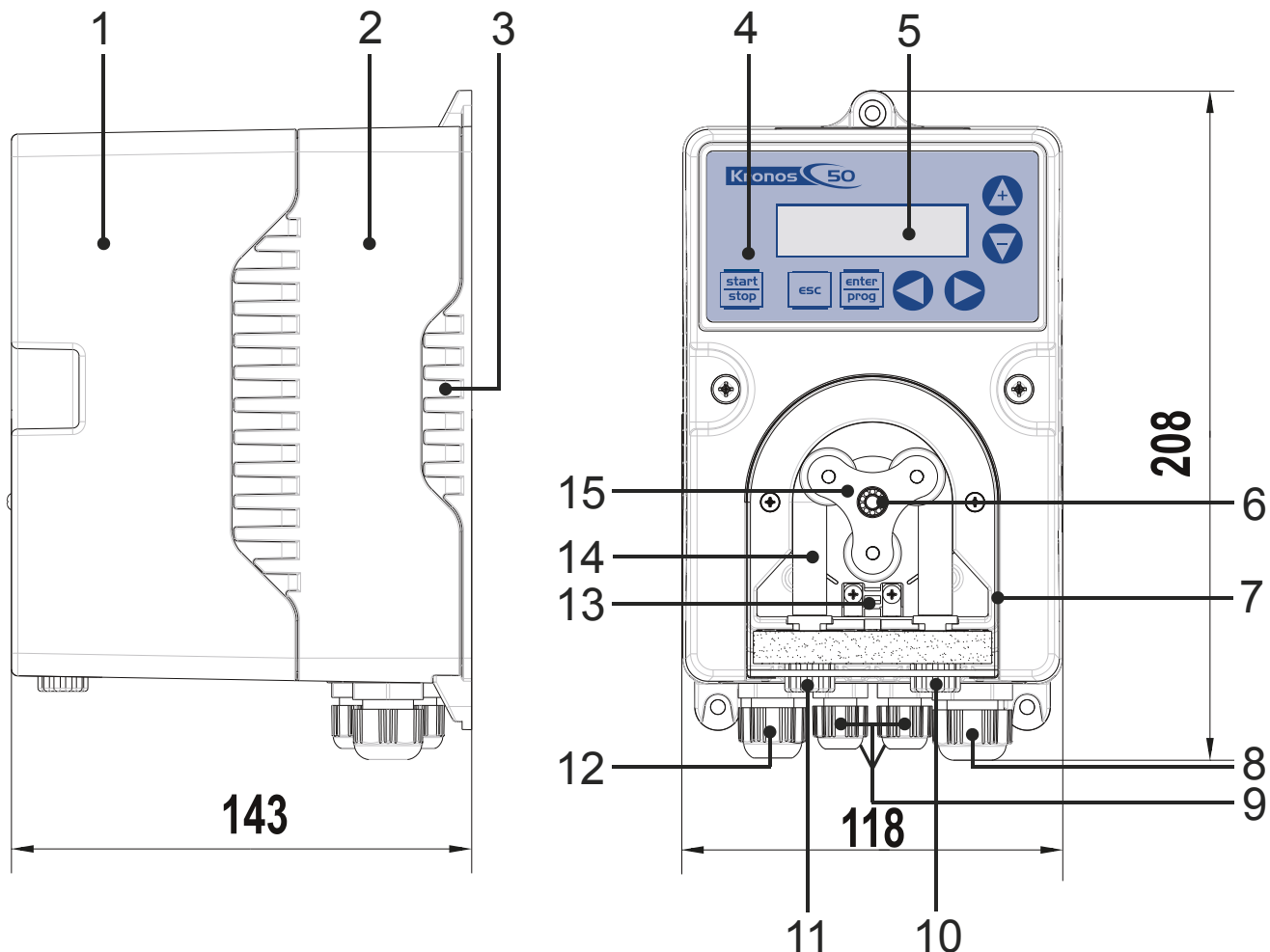

1	Alloggio: sezione superiore	9	PCBs 7
2	Alloggio: sezione centrale	10	Connettore di scarico
3	Alloggio: sezione inferiore	11	Connettore di aspirazione
4	Tasti di comando	12	PCB 9
5	Schermo LCD	13	Monitoraggio della rottura del tubo
6	Cuscinetto a sfera	14	Tubo della pompa
7	Coperchio trasparente	15	Rotore
8	PCB 11		

4. DESIGN E DESCRIZIONE FUNZIONALE

La pompa comprende due componenti principali:

- Unità di azionamento (motore passo –passo)
- Testa dosatrice (rotore, rulli e tubo della pompa)

Unità operativa

Il dispositivo è ospitato in un alloggio in plastica resistente composto da sezioni superiori e inferiori avvitate insieme. La sezione inferiore contiene il PCB per l'alimentazione e i connettori.

La sezione superiore dell'alloggio ospita il CPU, il motore e il display del PCB con lo schermo e i pulsanti.

La testa dosatrice è montata frontalmente ed è chiusa da un coperchio trasparente avvitato che la protegge dall'esterno. Il tubo della pompa può essere facilmente sostituito dopo aver rimosso il coperchio trasparente.

Il movimento rotatorio dei rotori preme e distende alternativamente il tubo della pompa attraverso tre rulli. Di conseguenza, il liquido viene aspirato e trasportato attraverso il tubo flessibile.

La pompa viene azionata dall'unità motrice. Attraverso tale unità, è possibile configurare la modalità e il livello di dosaggio desiderato. Il dosaggio è controllato con l'unità motrice o attraverso un contatto esterno, l'ingresso del livello.

5. INSTALLAZIONE

1. Segnare sulla parete i fori alesati
2. Perforare dei fori da 8 mm di diametro e inserire le spine fornite
3. Fissare la staffa al muro
4. Appendere il dispositivo sopra la staffa

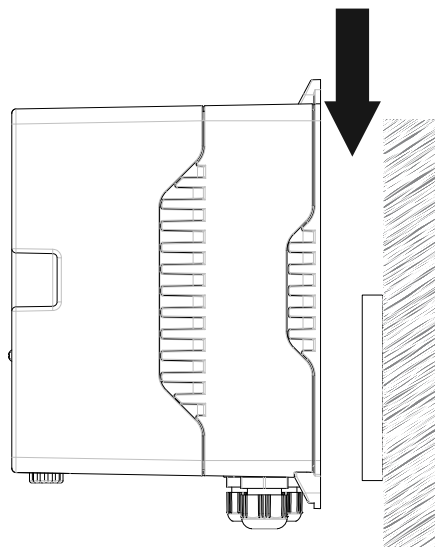
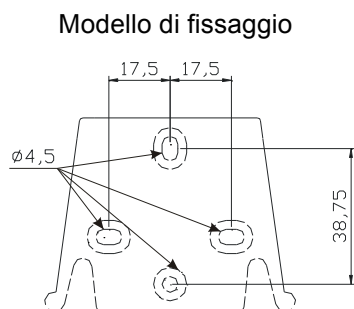

6. INSTALLAZIONE IDRAULICA

Installare le linee di aspirazione e scarico:

1. Tagliare le parti terminali dei tubi in modo che siano dritti.
2. Avvitare il dado cieco e farlo scorrere sul tubo.
3. Avvitare la parte terminale del tubo finché non si blocca sull'ugello.
4. Collegare la linea di scarico al collegamento del tubo di destra.
5. Collegare la linea di aspirazione al collegamento del tubo di sinistra.
6. Serrare i dadi ciechi.
7. Per farlo, accorciare la parte terminale libera della linea di aspirazione in modo che si trovi appena sopra al fondo del contenitore.
8. Se necessario, alimentare una linea del tubo dal raccordo di trafilamento nel contenitore.

7. INSTALLAZIONE ELETTRICA

1. Stendere un cavo di corrente con protezione contro il corto circuito e interruttore di rete e, se necessario, un interruttore per l'arresto d'emergenza.
2. Assicurarsi che il cavo di alimentazione di rete non sia attivo!
3. Allargare il piccolo foro alesato che si trova in fondo a destra della sezione posteriore attraverso un giravite.
4. Avvitare la vite corrispondente e serrare.
5. Inserire i riduttori in base al diametro di cavo utilizzato e inserire il gruppo filettato.
6. Inserire il cavo di corrente nel gruppo filettato.
7. Collegare il cavo di corrente al blocco terminale.
8. Serrare la vite di serraggio in modo che il gruppo filettato sia a prova di umido.

6.1 Connessioni elettriche

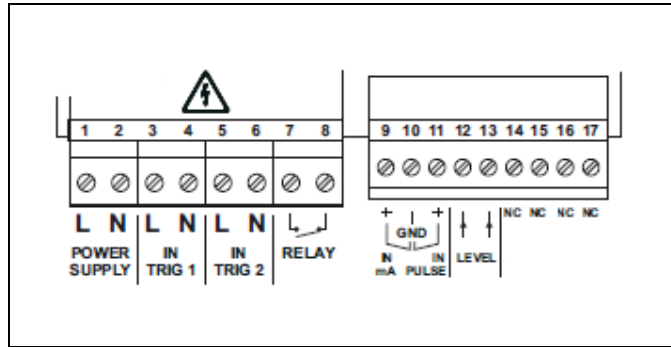

Numero di terminale	Descrizione	Specifiche elettriche	
1 - 2	Alimentazione di corrente	100÷240 VAC (50–60Hz)	
3 - 4	Innesco 1 segnale d'ingresso	24÷240 VAC or VDC	
5 - 6	Innesco 2 segnale d'ingresso	24÷240 VAC or VDC	
7 - 8	Uscita del relè di allarme	250VAC 8A	
9 - 10	9 Polo + (mA)	mA Ingresso	0/4÷20 mA (Impedenza ingresso: 200 ohm)
	10 Polo - (GND)		
10 - 11	10 Polo - (GND)	Ingresso impulsi	Impulsi privi di tensione (contatore di emissioni impulso, contatto privo di tensione: on-off, frequenza massima 1KHz)
	11 Polo + (Impulso)		
12 - 13	Ingresso per sonda di controllo di livello	Contatto privo di tensione (on-off)	
14 -15 -16 -17	Non usato	Non usato	

8. UNITÀ OPERATIVA

8.1 Tasti di comando





I tasti di comando sono designati nel seguente modo:

Tasto	Descrizione
	Avvia e arresta la pompa. In caso di allarme di livello (solo funzione di allarme), allarme di flusso e allarme di memoria attiva, disattiva il segnale sul display.
	Usato per "uscire" dai diversi livelli di menù. Prima di uscire definitivamente dalla fase di programmazione, verrà chiesto all'operatore se desidera salvare eventuali modifiche.
	Premuto durante la fase operativa della pompa, visualizza ciclicamente i valori programmati sul display. Premendo insieme i tasti o , aumenta o riduce il valore in base alla modalità operativa selezionata. Durante la programmazione, svolge una funzione di "invio", ossia conferma l'inserimento ai diversi livelli di menù e le modifiche apportate.
	Usato per scorrere verso l'alto il menù
	Usato per scorrere verso il basso il menù o per l'adescamento, tenendolo premuto per almeno 3 secondi, la pompa inizia a lavorare al 100% finché non si preme il tasto .
	Serve per aumentare i valori numerici da modificare. Può essere utilizzato per avviare il dosaggio in modalità Lotto.
	Usato per diminuire i valori numerici da modificare.

8.2 Menù di programmazione

Si può accedere al menù di programmazione premendo il tasto .

Si possono usare i tasti   per scorrere le voci di menù, mentre il tasto  serve per accedere alle modifiche.

La pompa è programmata di default in modalità costante. La pompa torna automaticamente alla modalità operativa dopo 1 minuto d'inattività. In questo caso però, i dati inseriti non saranno salvati.



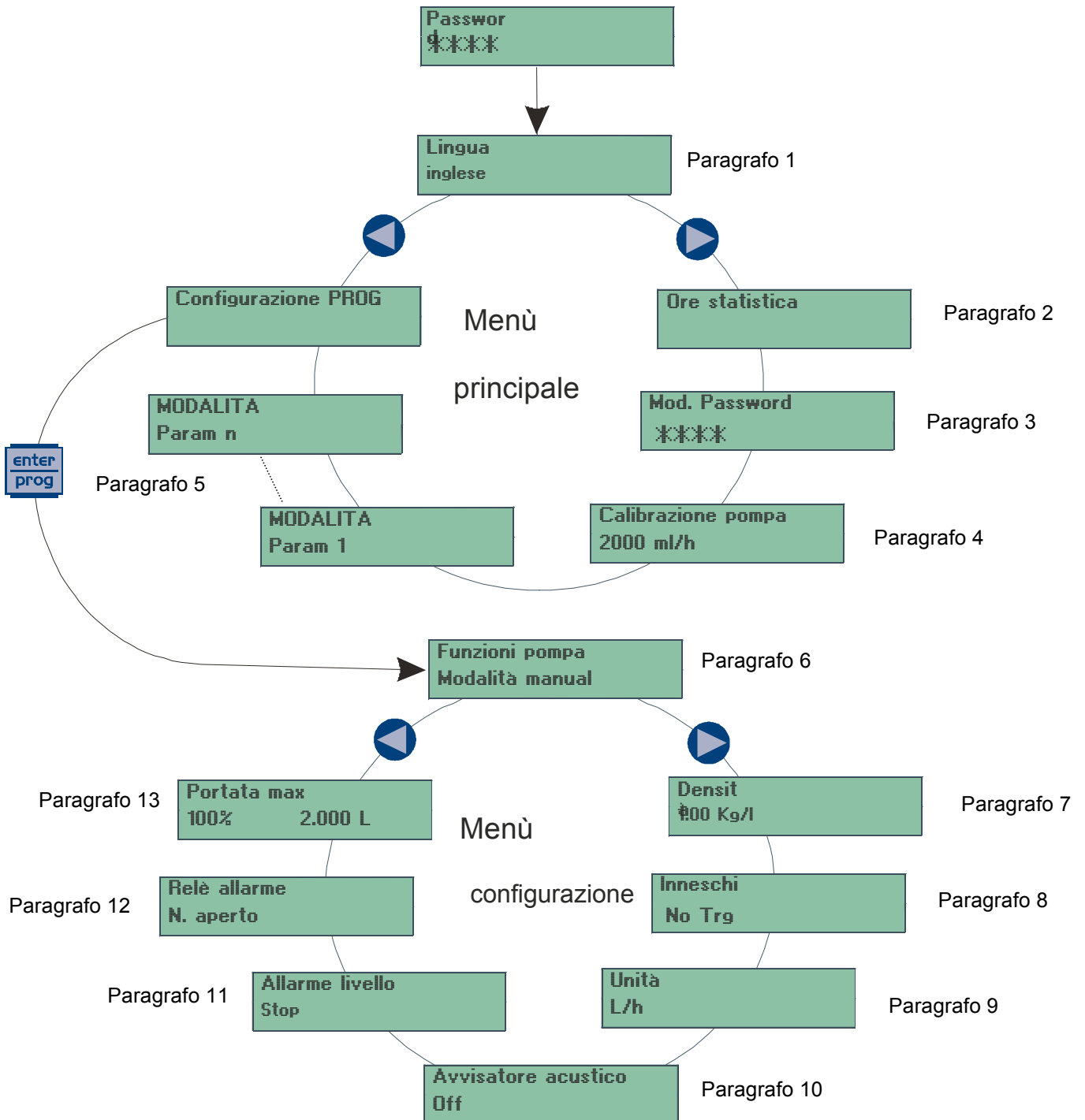

Usare il tasto  per uscire dai diversi livelli di programmazione.

Uscendo dalla programmazione, si visualizzerà:







    per confermare la selezione.







Paragrafo 1

Programmazione	Operazione
	<p>Consente di selezionare la lingua. La pompa è configurata di default in inglese.</p> <p>Per effettuare modifiche, premere il tasto , quindi usare i tasti   per impostare un nuovo valore.</p> <p>Premere  per confermare e tornare al menù principale.</p>



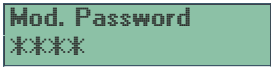

Paragrafo 2

Programmazione	Operazione
	<p>Il menù principale visualizza il numero di volte in cui è stata azionata la pompa.</p> <p>Premendo il tasto  si accede ad altre statistiche:</p> <ul style="list-style-type: none">- Ore di tubo = ore di funzionamento dei tubi.- Q.tà (litri) = quantità dosata dalla pompa in litri.- Reset = usare i tasti   per resettare i contatori (SI) o altrimenti (NO), quindi confermare premendo il tasto . <p>Premendo il tasto  si torna al menù principale.</p>

Paragrafo 3

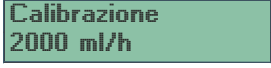
Programmazione	Operazione
	<p>Consente di modificare la password d'accesso.</p> <p>Effettuare le modifiche premendo il tasto , quindi usare i tasti   per configurare il nuovo valore.</p> <p>Per disabilitare la password, inserire il valore 0000.</p> <p>Premendo il tasto  si ritorna al menù principale.</p>

Paragrafo 4

Programmazione	Operazione
	<p>Per calibrare la pompa, procedere come segue:</p> <p>la pompa gira a massima velocità per 36 sec (versione 10 l/h) o 180 sec (versione 2 l/h), avviandola con il tasto .</p> <p>Alla fine di questo periodo, inserire la quantità aspirata usando i tasti   e confermare con il tasto .</p> <p>La cifra inserita serve per i calcoli di flusso.</p>

Paragrafo 5

Configurazione
PROG



Queste voci di menù sono diverse in base alle configurazioni dei menu

Funzione pompa
Modalità manuale :

- Modalità manuale
- Modalità mA
- Modalità PPM
- Modalità 1:N
- Modalità N:1
- Modalità Lotto

Modalità Manuale:



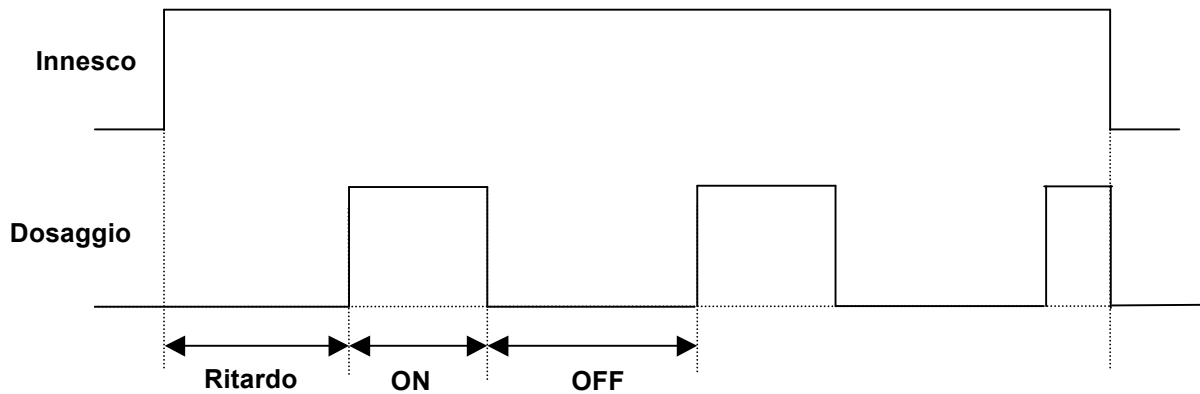

La pompa esegue il dosaggio alla portata di flusso selezionata. Impostando Tempo di OFF su 0 sec, la pompa lavorerà in maniera ininterrotta.

La pompa avvia il dosaggio dopo il tempo di ritardo selezionabile.

Es.: Dosaggio manuale con innesco.



Se non si seleziona un innesco, la pompa avvia il ritardo contando a partire dall'accensione.

Programmazione	Operazione
<div style="text-align: center;"> <div data-bbox="331 1406 603 1473" style="border: 1px solid black; padding: 2px; margin-bottom: 10px;">Modalità manuale Sec. tempo ON</div> <div style="text-align: center;">↓</div> <div data-bbox="322 1559 612 1626" style="border: 1px solid black; padding: 2px; margin-bottom: 10px;">Modalità manuale Sec tempo OFF</div> <div style="text-align: center;">↓</div> <div data-bbox="300 1711 638 1778" style="border: 1px solid black; padding: 2px;">Modalità manuale Sec tempo RITARDO</div> </div>	<p>La pompa lavora in modalità costante. Il flusso può essere regolato solo manualmente premendo contemporaneamente i tasti   per aumentare il flusso o i tasti   per ridurlo.</p> <p>Consente di configurare:</p> <ul style="list-style-type: none"> • Tempo di ON = Tempo di lavoro della pompa. • Tempo di OFF = Tempo di arresto della pompa. • Tempo di DELAY= tempo di ritardo al termine del quale la pompa si avvia.

Modalità mA:



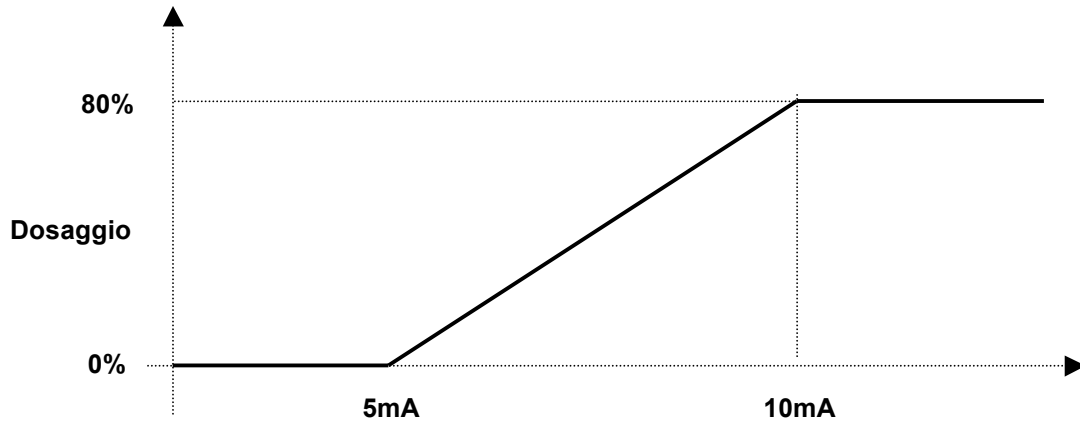

La pompa dosa in proporzione ad un segnale di (0)4-20 mA o di 20-4(0) mA. È possibile impostare il valore mA corrispondente allo 0% di dosaggio e il valore d'ingresso mA corrispondente alla portata massima di flusso della pompa.

Es.: Dosaggio mA **diretto**:
 ingresso mA per 0% = 5 mA
 ingresso mA per PORTATA DI FLUSSO MAX = 10 mA
 Portata di flusso massima = 80%

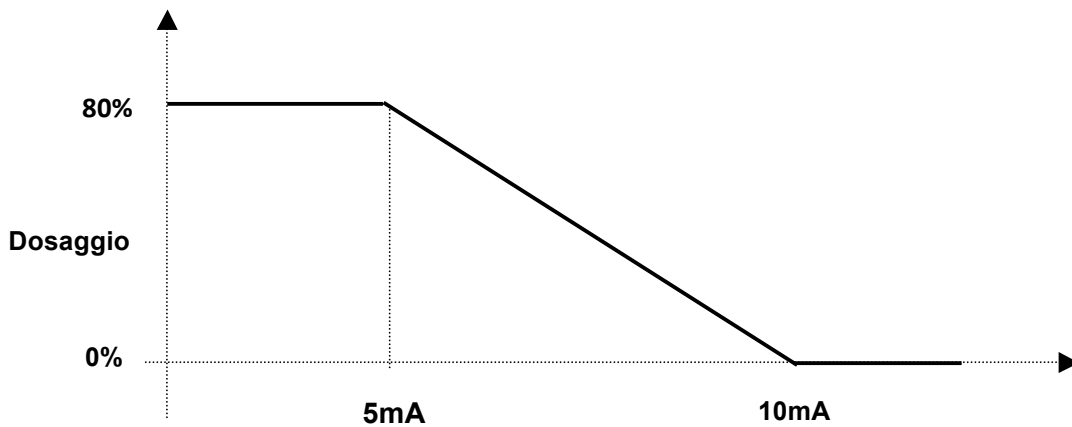

Es.: Dosaggio mA **inverso**:
 ingresso mA per 0% = 10mA
 ingresso mA per PORTATA DI FLUSSO MAX = 5mA
 Portata di flusso massima = 80%





Programmazione	Operazione
<div style="text-align: center;"> <div style="border: 1px solid black; padding: 5px; width: fit-content; margin: 0 auto;">Modalità mA MAX DOS @ 20.0mA</div> <div style="text-align: center; margin: 5px 0;">↓</div> <div style="border: 1px solid black; padding: 5px; width: fit-content; margin: 0 auto;">Modalità mA 0% DOS @ 04.0mA</div> </div>	<p>La pompa dosa in proporzione ad un segnale di 0/4-20 mA. In base alle impostazioni di default, la pompa interrompe il dosaggio a 0mA e dosa alla frequenza impostata massima quando riceve 20 mA. Questi due valori possono essere modificati durante la programmazione. È possibile modificare la frequenza massima e quella minima durante il funzionamento premendo contemporaneamente i tasti   per aumentare il flusso o i tasti   per ridurlo.</p>

Modalità PPM:

Per mantenere il ppm selezionato del prodotto chimico, la pompa calcola il giusto indice di dosaggio a partire dai seguenti parametri:

- Impulso al minuto sull'ingresso di impulsi
- Fattore flussometro (impulso/litro)
- Densità del prodotto chimico
- Concentrazione del prodotto chimico

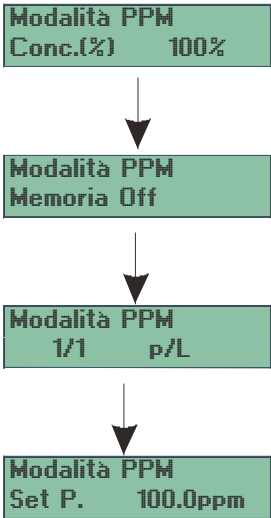
Se la portata calcolata è superiore alla portata massima, la pompa entra in funzione MEM (se selezionata) e dosa una quantità duratura ogni volta possibile.

Programmazione	Operazione
 <pre> graph TD A["Modalità PPM Conc.(%) 100%"] --> B["Modalità PPM Memoria Off"] B --> C["Modalità PPM 1/1 p/L"] C --> D["Modalità PPM Set P. 100.0ppm"] </pre>	<p>La pompa dosa in proporzione ad un segnale esterno (p.es.: contatore lancia impulsi), calcolando automaticamente la relazione tra i segnali in ingresso e la velocità della pompa sulla base del valore ppm programmato.</p> <p>La frequenza di dosaggio può essere modificata durante il funzionamento premendo contemporaneamente i tasti  per aumentare il flusso o i tasti  per diminuirlo.</p> <p>Consente di configurare:</p> <ul style="list-style-type: none"> • Conc.(%)= concentrazione di prodotto. • Memoria= La pompa ha una funzione di memoria che segnala la ricezione di un segnale durante il dosaggio. Se è impostata su Off, si limita ad inviare un segnale, se è su On invia un segnale e memorizza gli impulsi, quindi gli esegue appena finisce di ricevere segnali. • 1/1= numero di impulsi a litro (1/1-999/999). Di conseguenza, il sistema esegue il dosaggio in base ai valori impostati. • Set P.= valore ppm che doserà il sistema.

Modalità 1:N:

La pompa dosa seguendo il numero d'impulsi del relativo ingresso.

Un impulso in ingresso genera 1 secondo di dosaggio alla velocità configurata (N).





P.es.

- Impostando N su 1 (N=1), la pompa dosa per un secondo alla velocità = 1% della velocità massima
- Impostando N su 100 (N=100), la pompa dosa per un secondo alla velocità = 100% della velocità massima

versione	Dosaggio medio @ 1%*	Dosaggio medio @ 100%*
10000ml/h	0.027ml	2.77ml
2000ml/h	0.0055ml	0.55ml

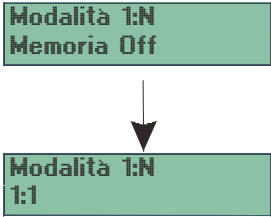
* quantità dosata in 1 secondo

Se la portata calcolata è superiore al valore massimo, la pompa entra in funzione MEM (se selezionata) e dosa la quantità duratura ogni volta possibile.

Programmazione	Operazione
<div style="text-align: center;">  </div>	<p>La pompa dosa in proporzione ad un segnale esterno (p.es.: contatore lancia impulsi). Con ogni segnale ricevuto, la pompa esegue 1 secondo alla velocità "N" programmata (p.es. 20%).</p> <p>Il valore di N può essere modificato durante il funzionamento premendo contemporaneamente i tasti   per aumentare il flusso o i tasti   per diminuirlo.</p> <p>Consente di configurare:</p> <ul style="list-style-type: none"> • Memoria = La pompa ha una funzione di memoria che segnala la ricezione di un segnale durante il dosaggio. Se è impostata su Off, si limita ad inviare un segnale, se è su On invia un segnale e memorizza gli impulsi, quindi gli esegue appena finisce di ricevere segnali. • 1:N = Con ogni segnale ricevuto, la pompa esegue 1 secondo alla velocità "N" programmata (p.es. 20%)

Modalità N:1:





La pompa dosa seguendo il numero d'impulsi del relativo ingresso.
 Gli impulsi in ingresso N generano 1 secondo di dosaggio all'1%
 p.es.

- Impostando N su 1 (N=1), la pompa dosa per un secondo alla velocità = 1% della velocità massima
- Impostando N su 100 (N=100), la pompa dosa per un secondo alla velocità = 100% della velocità massima

versione	Dosaggio medio @ 1%*	Dosaggio medio @ 100%*
10000ml/h	0.027ml	2.77ml
2000ml/h	0.0055ml	0.55ml

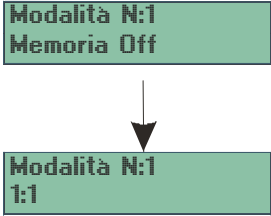
* quantità dosata in 1 secondo







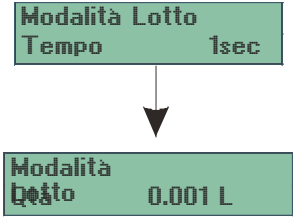

Se la portata calcolata è superiore al valore massimo, la pompa entra in funzione MEM (se selezionata) e dosa la quantità duratura ogni volta possibile.

Programmazione	Operazione
<div style="text-align: center;">  </div>	<p>La pompa dosa in proporzione ad un segnale esterno (p.es.: contatore lancia impulsi). Con ogni segnale "N" programmato che riceve, la pompa esegue 1 secondo all'1% della velocità massima.</p> <p>Il valore di N può essere modificato durante il funzionamento premendo contemporaneamente i tasti   per aumentare il flusso o i tasti   per diminuirlo.</p> <p>Consente di configurare:</p> <ul style="list-style-type: none"> • Memoria= La pompa ha una funzione di memoria che segnala la ricezione di un segnale durante il dosaggio. Se è impostata su Off, si limita ad inviare un segnale, se è su On invia un segnale e memorizza gli impulsi, quindi gli esegue appena finisce di ricevere segnali. • N:1 = Con ogni "N" programmato che riceve, la pompa esegue 1 secondo all'1% della velocità massima.

Modalità Lotto:

La pompa dosa alla quantità selezionata quando viene premuto il tasto UP o quando viene letto un impulso sull'ingresso (altri impulsi sono ignorati quando la pompa sta dosando) o, se si selezionano i segnali d'innesco, quando viene letto un segnale d'innesco valido in ingresso.

Se il tempo selezionato per il dosaggio è troppo breve, la pompa dosa alla portata massima.

Programmazione	Operazione
 <p>The diagram shows a box labeled 'Modalità Lotto Tempo 1sec' with a downward arrow pointing to a box labeled 'Modalità Qttà 0.001 L'.</p>	<p>La pompa dosa in proporzione ad un segnale esterno (p.es.: contatore lancia impulsi). In questo caso, è possibile impostare la quantità da dosare in l e il tempo entro il quale completare il dosaggio. È possibile avviare manualmente il dosaggio premendo il tasto  o utilizzando un comando a distanza. Il tasto  interrompe il dosaggio. È possibile ripristinare il dosaggio già effettuato premendo  o riavviarlo premendo di nuovo il tasto  .</p> <p>La quantità da dosare può essere modificata durante il funzionamento premendo contemporaneamente i tasti   per aumentare il flusso o i tasti   per diminuirlo.</p> <p>Consente di configurare:</p> <ul style="list-style-type: none"> • Tempo = il tempo espresso in secondi entro il quale completare il dosaggio • Qtà = la quantità da dosare espressa in litri

Paragrafo 6

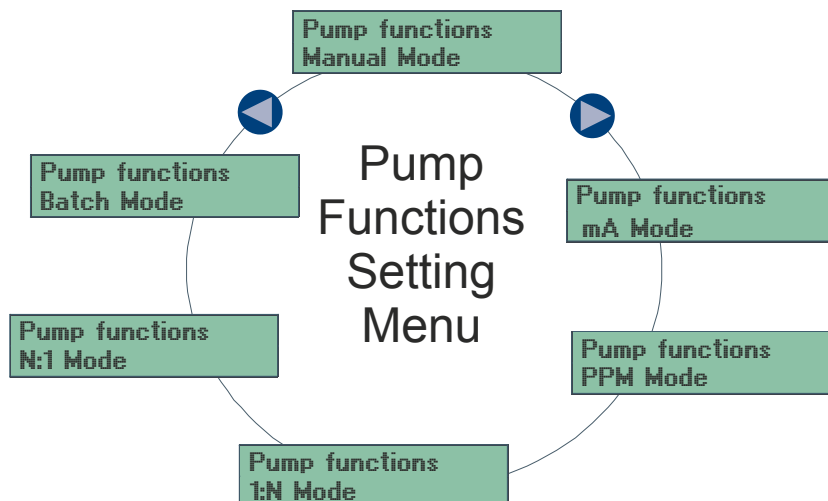

Paragrafo 7

Programmazione	Operazione
Densità 1.00 kg/L	Consente di configurare la densità del prodotto chimico.

Paragrafo 8

Programmazione	Operazione
Inneschi No Trg	Consente di impostare gli inneschi in ingresso. Quando sono presenti inneschi, consente alla pompa di funzionare, in base alla funzione configurata: <ul style="list-style-type: none">• No Trg = gli inneschi sono disabilitati.• Trg 1 = la pompa si avvia solo quando l'innesco 1 è abilitato.• Trg 2 = la pompa si avvia solo quando l'innesco 2 è abilitato.• Trg 1&2 = la pompa si avvia quando entrambi gli inneschi (1&2) sono abilitati.

Paragrafo 9

Programmazione	Operazione
Unità L/h	Consente di configurare l'unità di misura, che può essere: <ul style="list-style-type: none">• L/h = litro all'ora.• ml/m = millimetro al minuto.• Gph = Gallone all'ora.• % = percentuale della portata massima.

Paragrafo 10

Programmazione	Operazione
Avvisatore acustico Off	L'avvisatore acustico è attivo quando esiste una condizione di allarme. Questo consente di importare l'avvisatore acustico del sistema su On o Off.

Paragrafo 11

Programmazione	Operazione
Allarme livello Stop	Consente di configurare come segue l'allarme di livello: <ul style="list-style-type: none">• Arresto = la pompa si arresta• Funzionamento = la pompa continua a lavorare.

Paragrafo 12



Programmazione	Operazione
Relè allarme N.Aperto	Consente di configurare come segue il relè dell'allarme: <ul style="list-style-type: none">• N.Aperto = normalmente aperto.• N.Chiuso = normalmente chiuso.



Paragrafo 13

Programmazione	Operazione
Portata max 100% 10.000 L	Consente di configurare il flusso massimo offerto dalla pompa e si usa la modalità programmata (% o frequenza) come l'unità di misura standard quando si visualizza il flusso.



9. Manutenzione

9.1 Sostituzione dei tubi

Con la pompa in Arresto (premere il tasto , se si preme per almeno 3 secondi il tasto  la pompa inizia a funzionare in senso antiorario alla massima velocità per facilitare la rimozione del tubo. Per arrestare la pompa, premere il tasto .

Con la stessa procedura, se si preme per almeno 3 secondi il tasto  la pompa inizia a funzionare in senso orario alla massima velocità per facilitare la rimozione del tubo. Per arrestare la pompa, premere il tasto .

9.2 Contrasto LCD

Con la pompa in Arresto (premere il tasto , premere i tasti  e  per aumentare o ridurre il contrasto.

10. Visualizzazione del display

10.1 Durante il dosaggio

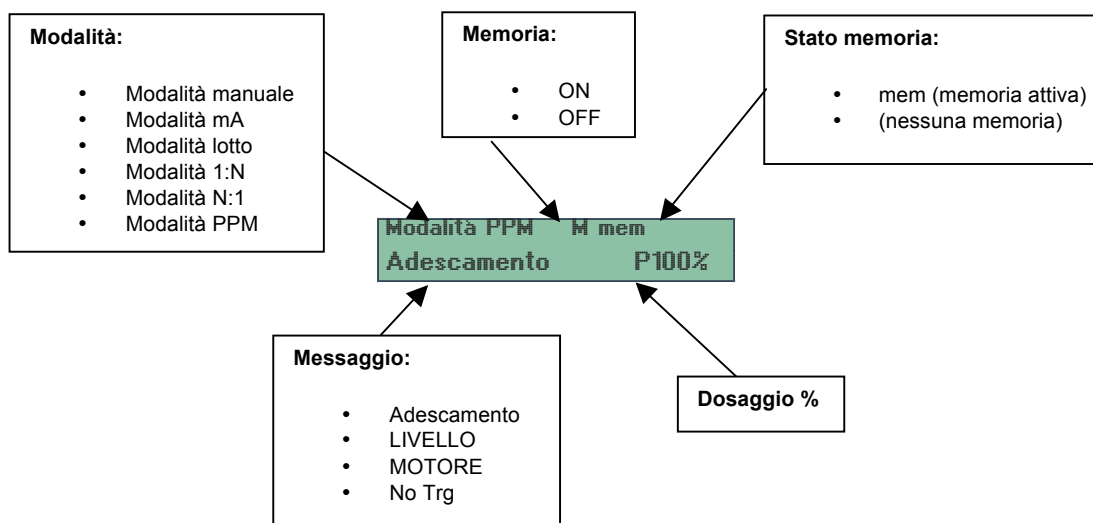

10.2 Durante l'arresto

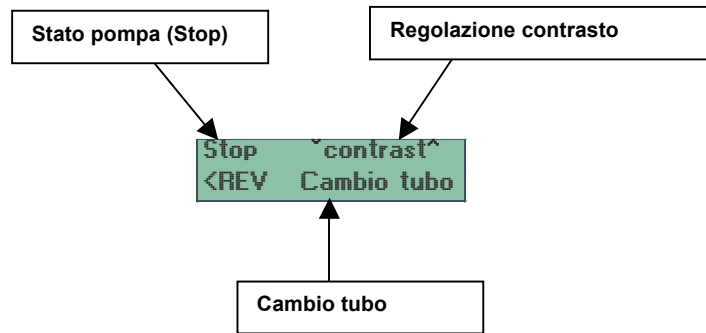

11. CONFIGURAZIONE RAPIDA DEI PARAMETRI

Dalla modalità di visualizzazione del dosaggio, premere per almeno 3 secondi il tasto  per visualizzare il menù di configurazione rapida:

```
Modalità manuale
Max %      100%
```

In questo menù si possono modificare le seguenti voci:

1) Portata massima in:

- Modalità mA
- Modalità manuale

2) N in:



- Modalità 1:N
- Modalità N:1

3) Quantità in:

- Modalità Lotto

4) ppm in

- Modalità PPM

Per modificare il valore corrente, tenere premuto  con i tasti  o .

12. Elenco dei parametri

	Parametro	Valore	Valore	Valore	Valore	Valore	Valore	Default
1	Lingua	inglese	tedesco	italiano				inglese
2	Password	0 - 9999						0 (disabilitata)
3	Statistiche	Ore di dosaggio	Ore di tubi	litri				
4	Portata max	0.1 – 100.0%						100.0%
5	Funzione pompa	Modalità manuale	Modalità mA	Modalità Lotto	Modalità 1:N	Modalità N:1	Modalità PPM	Modalità manuale
6	Relè allarme	N.aperto	N.Chiuso					N.Aperto
7	Allarme di livello	Arresta	Avvia					Arresta
8	Avvisatore acustico	ON	OFF					OFF
9	Unità	ml/h	L/h	%				ml/h
10	Innesco	No Trg	Trg 1	Trg 2	Trg 1&2			No Trg
11	Densità	0.50-2.00						1.00
12	Tempo di On	0-10000						10
13	Tempo di Off	0-10000						0
14	Tempo di ritardo	0-10000						0
15	mA per 0%	0.0-20.0						4.0
16	mA per max.	0.0-20.0						20.0
17	N	1-1000						1
18	impulso	1-2000						1
19	litro	1-2000						1
20	Conc. chimica	1-100						100
21	ppm	0-10000						1000
22	memoria	ON	OFF					OFF
23	quantità	0-30000						1
24	tempo	0-10000						1
25	Portata	Calibr.						10000

13. Tabella di parametri di dosaggio

Modalità	Param 1	Param 2	Param 3	Memoria	Innesco	Portata max	Densità
Manuale	Sec. tempo di ON (<u>0</u> -10000)	Sec. Tempo di OFF (<u>0</u> -10000)	Sec. tempo di RITARDO		INNESCO (<u>No Trg</u> /Trg 1/Trg 2/Trg 1&2)	PORTATA MAX. (0.1 – <u>100</u> %)	
Diretto o Inverso mA	Ingresso mA per dosaggio min (<u>0.0</u> -20.0 mA)	Ingresso mA per dosaggio max (0.0- <u>20.0</u> mA)			INNESCO (<u>No Trg</u> /Trg 1/Trg 2/Trg 1&2)	PORTATA MAX. (0.1 – <u>100</u> %)	
PPM	Set Point (<u>1</u> -3000 ppm)	Fattore flussometro (<u>1</u> -2000 pul / 1-2000 Lit)	CONC. CHIMICA (1- <u>100</u> %)	MEMORIA (ON- <u>OFF</u>)	INNESCO (<u>No Trg</u> /Trg 1/Trg 2/Trg 1&2)		DENSITÀ (0.50 – 2.00 kg/L) <u>1.00</u>
Lotto	Quantità (<u>1</u> -30.000ml)	Sec. tempo (<u>1</u> -10000)		MEMORIA (ON- <u>OFF</u>)			DENSITÀ (0.50 – 2.00 kg/L) <u>1.00</u>
PROP 1:N	N (<u>1</u> -1000)			MEMORIA (ON- <u>OFF</u>)	INNESCO (<u>No Trg</u> /Trg 1/Trg 2/Trg 1&2)		
PROP N:1	N (<u>1</u> -1000)			MEMORIA (ON- <u>OFF</u>)	INNESCO (<u>No Trg</u> /Trg 1/Trg 2/Trg 1&2)		

I parametri di default sono quelli in grassetto e sottolineati

14. Tabella allarmi

allarme	dosaggio	Display	Emettitore acustico	Relè
Rottura tubo	arresto	ROTTURA TUBO	ON se selezionato	ON se selezionato
Livello	Arresto se selezionato	LIVELLO	ON se selezionato	ON se selezionato
Motore	arresto	MOTORE	ON se selezionato	ON se selezionato